

LITPA

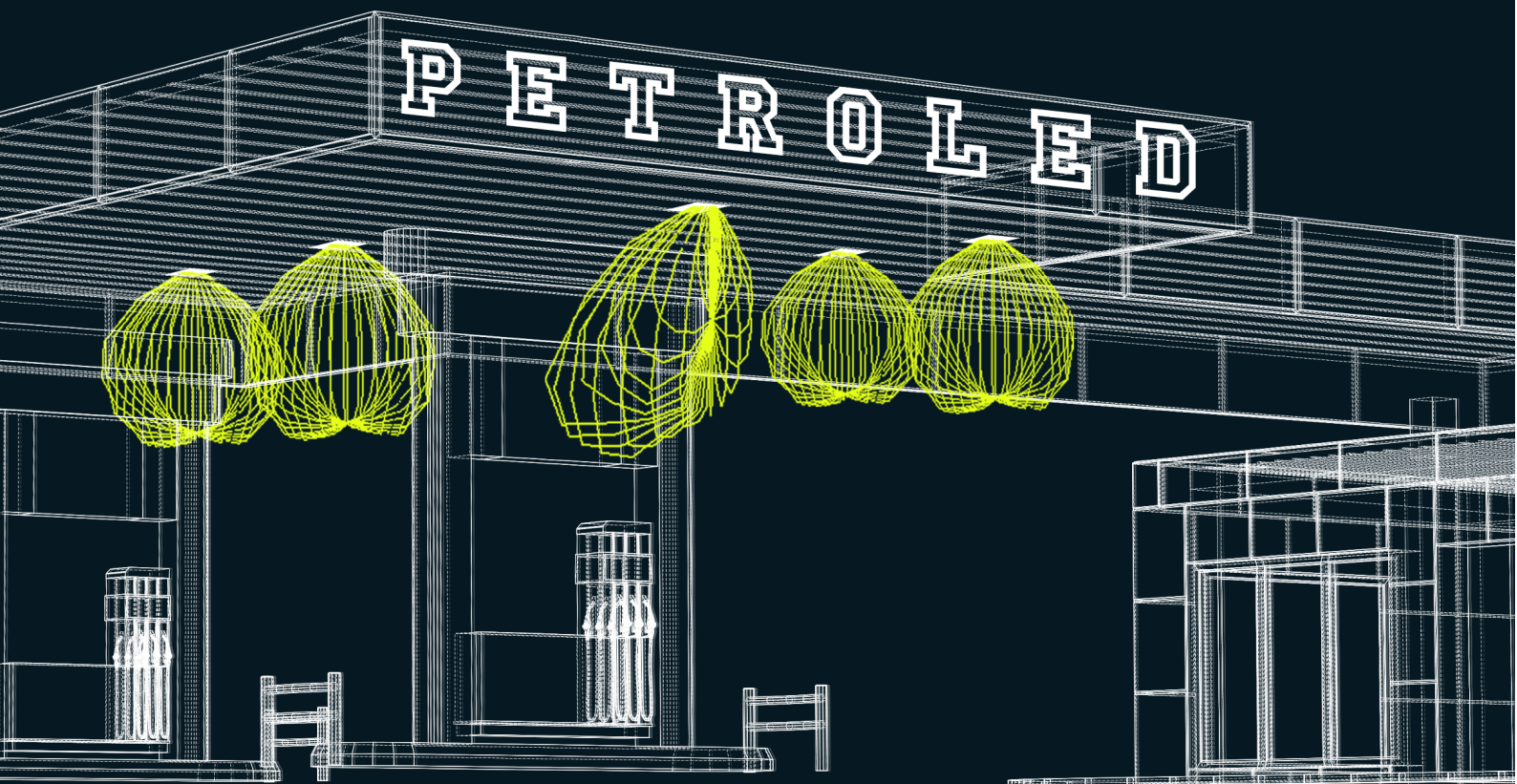



## PTL

PETROLED series luminaires produced as canopy luminaires and which can be used under fringes are robust luminaires and are resistant against exterior ambient conditions with durable die-cast aluminum body. Luminaires can be produced symmetrical or asymmetrical according to requirement.

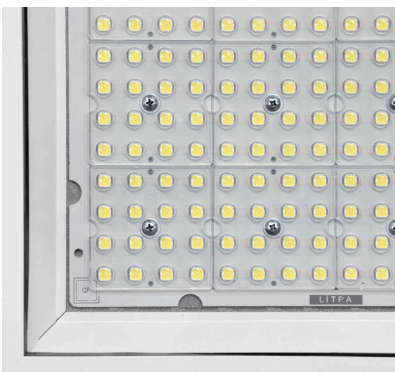

Various lens structures with high transmittance used in the fixtures fully meet the light requirement of fuel stations.

Symmetrical and asymmetrical lenses distribute the light coming from the LEDs to the surfaces as desired.

The diffuser is highly permeable and clear.

High efficiency LEDs up to 150lm / W are used.



Thanks to its light but robust aluminum body structure, PETROLED can cool well even in narrow spaces. In this way, the life of the LEDs used in the luminaire is prolonged. Petroled, which is a high protection class luminaire, is not affected by humid and dusty environments. The slim frame structure fits perfectly on the ceiling surfaces.

**PTL**



Body: Aluminum injection  
 Diffuser: Tempered glass  
 Optics: Symmetrical and asymmetrical beam  
 Voltage: 220V - 50 Hz

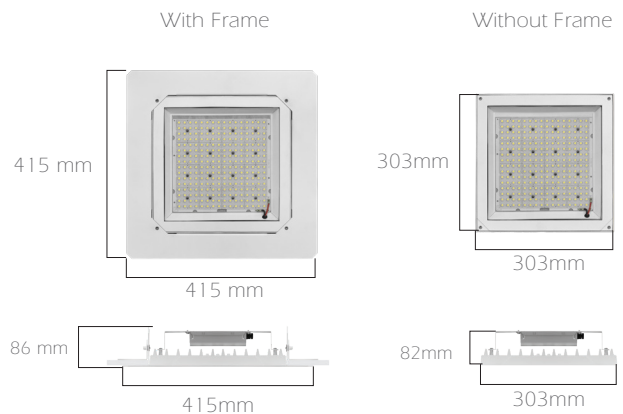
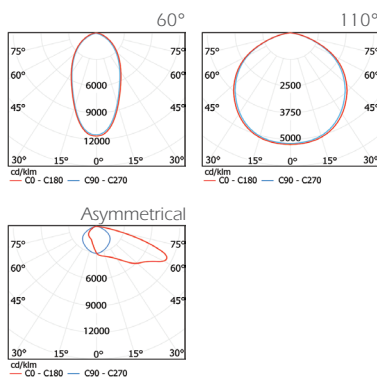

These are the standart frame sizes. The frame sizes can be produced in desired dimensions, provided that is not smaller than the size of the of the fixture.

Code	Beam	LED Type	Luminous flux	System Power	Colour Temperature	Cut-Out	Weight	Box Dimension
PTL/75	110°	Midpower LED	11.100lm	75W	3000-4000-5000-6500K	340 x 340mm	5.1kg	43x43x14cm
PTL/75/S	60°	Midpower LED	10.950lm	75W	3000-4000-5000-6500K	340 x 340mm	5.2kg	43x43x14cm
PTL/75/AS	Asym.	Midpower LED	10.000lm	75W	3000-4000-5000-6500K	340 x 340mm	5.2kg	43x43x14cm
PTL/100	110°	Midpower LED	14.400lm	100W	3000-4000-5000-6500K	340 x 340mm	4.9kg	43x43x14cm
PTL/100/S	60°	Midpower LED	13.700lm	100W	3000-4000-5000-6500K	340 x 340mm	5.0kg	43x43x14cm
PTL/100/AS	Asym.	Midpower LED	12.900lm	100W	3000-4000-5000-6500K	340 x 340mm	5.0kg	43x43x14cm

Luminous flux measured at 4.000K

### LED

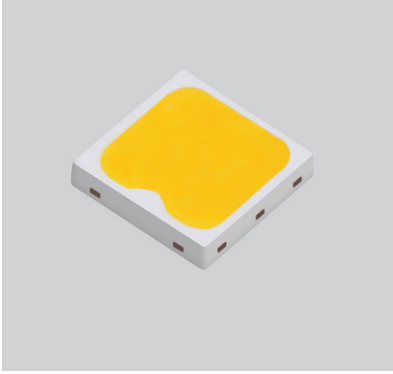

- High efficiency
- Long lasting
- 30x30 Midpower Outdoor Led
- CRI Min. 80
- ROHS Compliant
- PCT Package provides better cooling
- The driving current values of the LEDs are planned not to exceed 50 percent of the maximum driving current values.

Leds with 1.5W power were used with a power of 0.25W. In this way, very long LED lifetimes are obtained.

$$I_{Typ} = 150mA \quad I_s = 41mA$$

$$I_{Max} = 250mA \quad P_s = 0,25W$$

$$V_F = 6V \quad T_J = 125C^\circ$$

### Optics

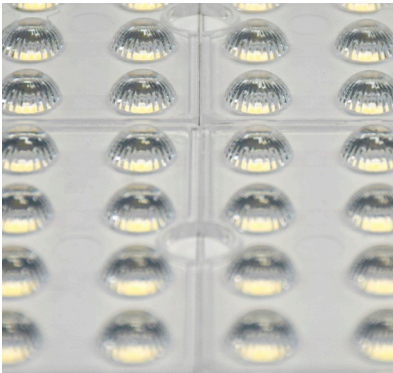

- High efficiency lens
- UV resistant acrylic lens
- High quality material
- Different beam angles
- Efficiency 93%
- FW TM: 30°C ~ 80°C
- Clear

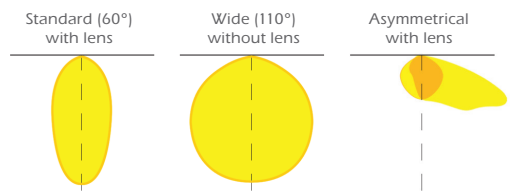

### Driver



- Low THD, <10% Max up to 240 Vac
- High Efficiency (Up to 91%)
- Input Surge Protection: 4kV line-line, 6kV line-earth
- Long Lifetime: 96,000 Hrs. at 70°C Case Temperature
- Waterproof (IP67)
- 140 ~ 300 Vac
- Power Factor >0.96

### Cables

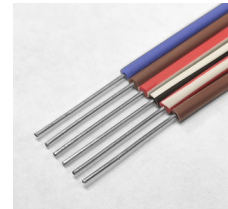

All cables used in luminaires are tin-plated copper.

### PCB

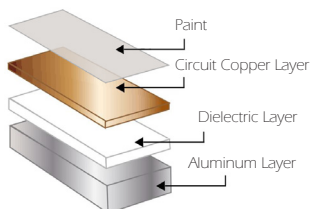

- Excellent heat dissipation
- Good heat stress performance
- Excellent reliability
- UL certificate
- RoHS compliance
- Halogen free, and HI, Pb & Sulphur Free
- Thermal conductivity: 1.0 W/m\*K
- Thermal shock : >120sec
- Thermal impedance : 1.1°C/W
- Dielectric thickness : 110Um
- Breakdown Voltage : 3.0KV/AC
- Hi-pot Voltage : 4.0KV/DC

### Frame



Standard dimensions are given for the frame. The frame sizes can be produced in desired dimensions, provided that is not smaller than the size of the of the fixture. In this way, you can replace your existing luminaires with Litpa luminaires.

## Motion Sensor



The sensors used increase the light when a vehicle enters a certain area. These sensors can control designated areas for each luminaire.

Energy consumption is reduced by installing motion sensors on luminaires. The system is activated when it gets dark and when vehicle mobility decreases at the station. Lighting fixtures on the pump dim the light when there is no activity in its area. In this case, only a safe level of illumination is provided.

(10-30%)

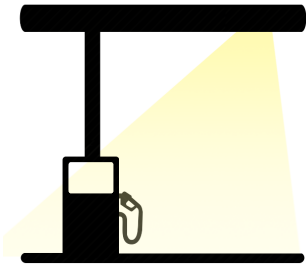

(100%)

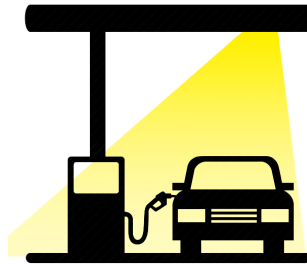

L İ T P A

## LİTPA LIGHTING

Haraççı - Hadımköy Yolu Cad.  
No:15 Haraççı Mah. 34281  
Arnavutköy - İstanbul / TURKEY  
Phone : +90 212 683 09 87  
Fax : +90 212 683 09 92

[www.litpa.com](http://www.litpa.com)