



LITPA Lighting was founded in 1992 with the sole intention of ensuring the manufacture and direct marketing of quality lighting solutions through its extensive and quality range of lighting fixtures. Our mission is to provide lighting solutions for indoor and outdoor settings that are not only reasonably priced, but due to our high-quality engineering and extensive research veritably “light-up your lives”.

LITPA seeks to provide not only suitable materials for use in its production, but also to ensure that it meets the lighting needs of the space in which it will be situated. For this reason, material quality that will meet the relevant lighting criteria alone is not enough. We also seek to fulfill the following criteria for our lighting solutions; that our fixtures must ensure viewing optimization, enhance and optimize the aesthetic value of the area in which fixtures are to be placed, ensure ease of mounting, wear-resistance appropriate to the conditions, suitability to the electrical supply; while also providing lighting comfort of the space to users, easy maintenance and economical usage. All of these considerations have been made in advance for you by our advanced and highly dedicated staff.









Our meticulous quality-control and attention to detail at every stage of the manufacturing process is of the utmost importance in our adherence to global standards. Every item, from the materials we use for products that we produce is checked to ensure the highest specifications of quality and performance.

Our company has placed a great deal of importance to its R&D (Research and Development) also, hence our dedicated, experienced and energetic team of professionals seeks always to surpass itself in provision of product and service delivery to our clients. With one call, we seek to be as close as possible to our clients – wherever they are and no matter where our offices are. LITPA’s progressive approach, values and guidelines has led to success with Turkey’s global corporations and business.

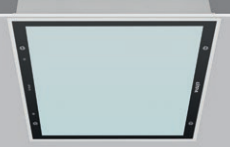
## OUTDOOR

<p>STREET LIGHTING 4 - 7</p>		<p>FLOODLIGHT 8 - 10</p>		<p>WALLWASHER &amp; LINEER 11 - 13</p>	
	<p>GROUND RECESSED 14 - 15</p>		<p>GARDEN LIGHTING 16 - 18</p>		<p>WALL LUMINAIRES 19</p>
<p>CANOPY LUMINAIRES 20</p>		<p>TUNNEL LIGHTING 21</p>			

## INDOOR

<p>DOWNLIGHT 24 - 37</p>		<p>SURFACE MOUNTED 38 - 39</p>		<p>OFFICE LIGHTING 40 - 49</p>	
	<p>HYGIENIC ROOM 50 - 51</p>		<p>LINEAR 52 - 56</p>		<p>DECORATIVE 57 - 59</p>
<p>WALL LUMINAIRES 60 - 63</p>		<p>INDUSTRIAL &amp; WEATHERPROOF 63 - 70</p>		<p>LINEAR for RETAILERS 72 - 75</p>	

# OUTDOOR LIGHTING

## LUMINAIRES





Street Lighting

STREETRAY

IP66

Streetray is a highly efficient IP66 protection class road lighting fixture which using LED technology. Our fixtures are produced in four different types. STREETRAY road fixtures can be used in all areas of road lighting including M1 motorways, urban street lighting and lighting of alleys. Its monolithic integrally cooled die-cast aluminum body structure extends the life of light source and reduces maintenance costs. Streetray also offers many features such as angle adjustable mounting bracket, channel water management and protective cover which can optionally be installed. The fixture's body is designed to be suitable for all kinds of urban automation. Automation systems which can be used in Wi-Fi, Zigbee, RF, PLC, Dali, KNX systems are also available upon request.



LYS 100

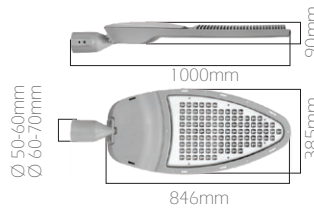

LYS 50

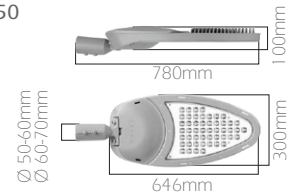

LYS 20



LYS 15

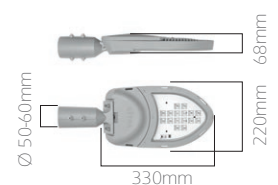

LYS 24V/DC Optional Solar System

Code	LYS 100 (Maxi)	LYS 50 (Midi)	LYS 20 (Mini)	LYS 15 (Micro)	LYS 20/DC (Solar)
LED	High Efficiency Power LED				
System Power	170 W 214 W 250 W 300 W	80 W 110 W 150 W	32 W 45 W 72 W	20 W 27 W 35 W	22 W 33 W 48 W
Light Flux	21,000 lm 27,120 lm 30,720 lm 35,690 lm	10,150 lm 13,750 lm 17,250 lm	4,060 lm 5,350 lm 7,500 lm	2,080 lm 3,000 lm 4,000 lm	2,910 lm 4,020 lm 5,400 lm
Colour Temperature	4000 - 5000 - 6500 K				
Voltage	220V - 50Hz				24 VDC
Body	Aluminum injection				
Optic	High-efficiency lens				
Cooler	Cooling from the surface of the aluminum body				
Glass	5 mm thick tempered and serigraphy printed				
Accessory	Anti-corrosive cover (only LYS50-LYS100)				
Colour	Grey				
Box Dimensions	102x40x12cm	78x33x13cm	60x27x12cm	60x27x10cm	60x27x12cm
Weight	15.200 gr	9.800 gr	5.700 gr	4.800 gr	5.700 gr

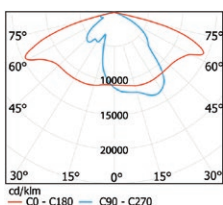

## Pedestrian Areas &amp; Walkways

## RINGA

## IP65



RNY4



RNY/T4 AGORA

Ringa, which in particular is preferred in parks, gardens, walking trails and residential areas, has been designed with the purpose of bringing diversity to the external environment thanks to the aesthetic design thereof. The aluminum body is manufactured according to protection class IP65 to be resistant to outdoor conditions. Usage height is on 4 to 6 meters high pole while way of mounting is on the top of a Ø60mm pole.

Highly efficient LEDs have been used and optimum drive currents have been preferred in Ringa fixtures in order to save energy. Ringa, designed to prevent light from escaping into the sky, has been designed also to prevent light pollution by virtue of this feature.



RNY2

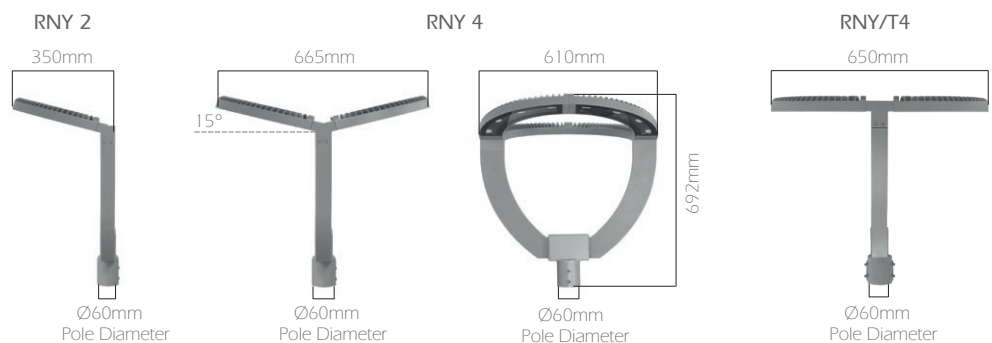

RNY OP

Simetrik Reflektör

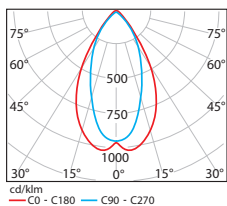

Asimetrik Reflektör

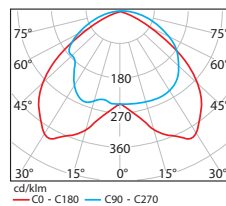

AGORA - RNY/T4

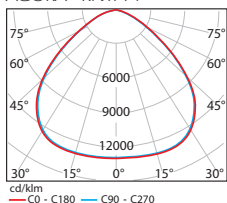

Code	RNY 2/70	RNY4/70 RNY4/100 RNY4/140	RNY/T4/250 RNY/T4/300
LED	High Efficiency Power LED		
System Power	70W	70W 100W 140W	250W 300W
Light Flux	6000 lm ~ 12670 lm		25900~ 28900 lm
Colour Temperature	3000 - 4000 - 5000 - 5700 - 6500 K		
Voltage	220V - 50Hz		
Body	Aluminum injection painted with electrostatic paint		
Cooler	Cooling from the surface of the aluminum body		
Optic	High Efficiency lenses; 21° - 26° - 45° - 65° - (21°+37°) or reflectors; 21° - 30° - 63° - 90°		
Glass	Clear glass, serigraphy printed		
Accessory	Apparatus for pole mounting		
Colour	Grey or RAL Color		
Box Dimensions	70x65x35 cm	70x65x70 cm	70x65x70 cm
Weight	9.800 gr	12.800 gr	12.800 gr

Pedestrian Areas & Walkways

CAIRO

IP66

These are designed to be cornered and integrated with the body except for the usual. In the design of luminaires, emphasis was placed on modern and aesthetic elements as much as light efficiency. Thanks to the LED module structures, luminaire powers can be adjusted to desired levels. High efficiency LEDs and optical structures provide the desired light levels and distributions.

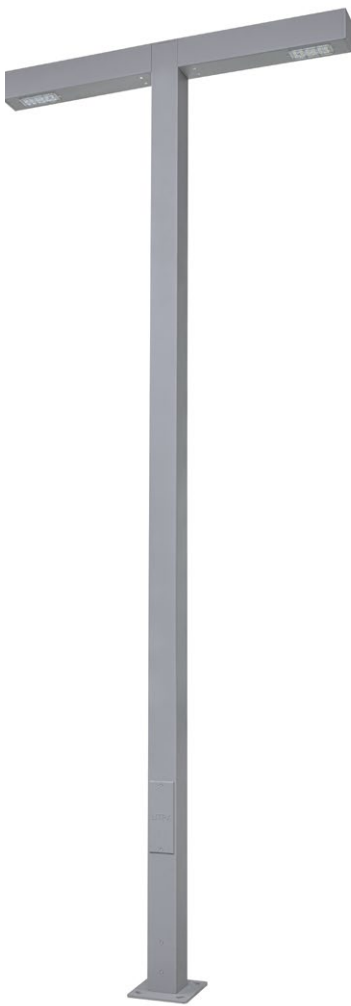

CRA2 Double Arm



CRA1 Single Arm

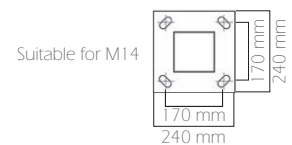
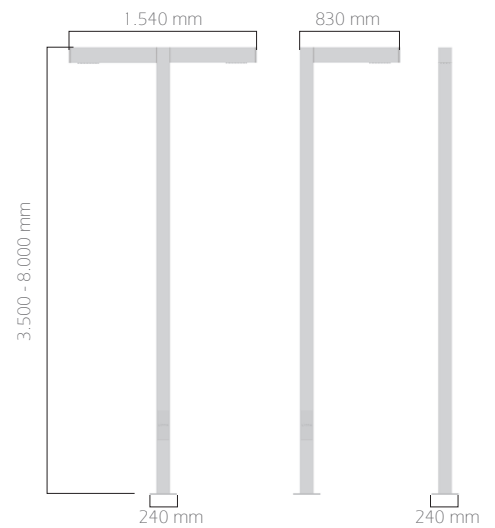
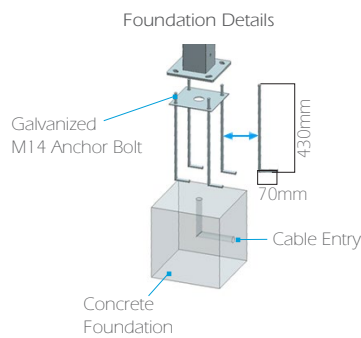

Code	CRA2	CRA1
LED	High Efficiency Power LEDs	
System Power	2x50W	1x50W
Light Flux	10.000lm	5000lm
Colour Temperature	4000 - 5000 - 6500 K	
Voltage	220V - 50Hz	
Body	Aluminum extrusion body, DKP sheet base thick 10mm	
Cooler	Cooling from the surface of the body	
Colour	Grey	

Pedestrian Areas & Walkways

BTL

BKL

IP65

These are designed to be cornered and integrated with the body except for the usual. In the design of luminaires, emphasis was placed on modern and aesthetic elements as much as light efficiency. Thanks to the LED module structures, luminaire powers can be adjusted to desired levels. High efficiency LEDs and optical structures provide the desired light levels and distributions.

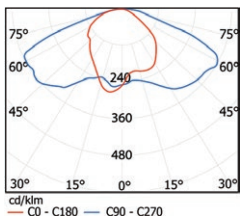
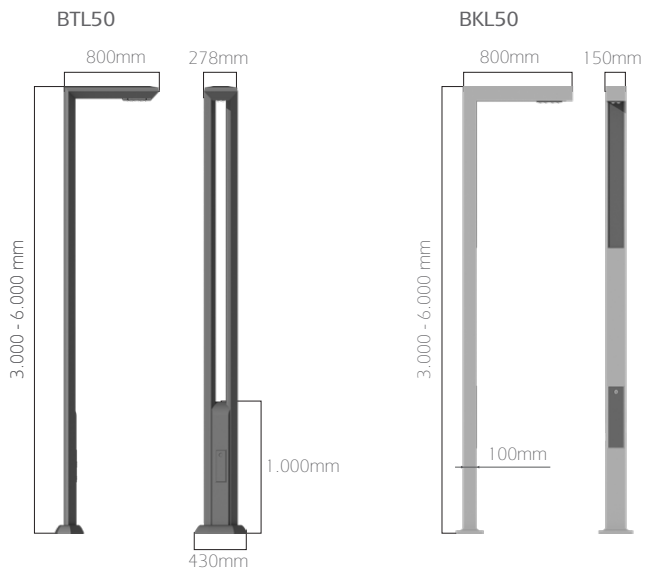
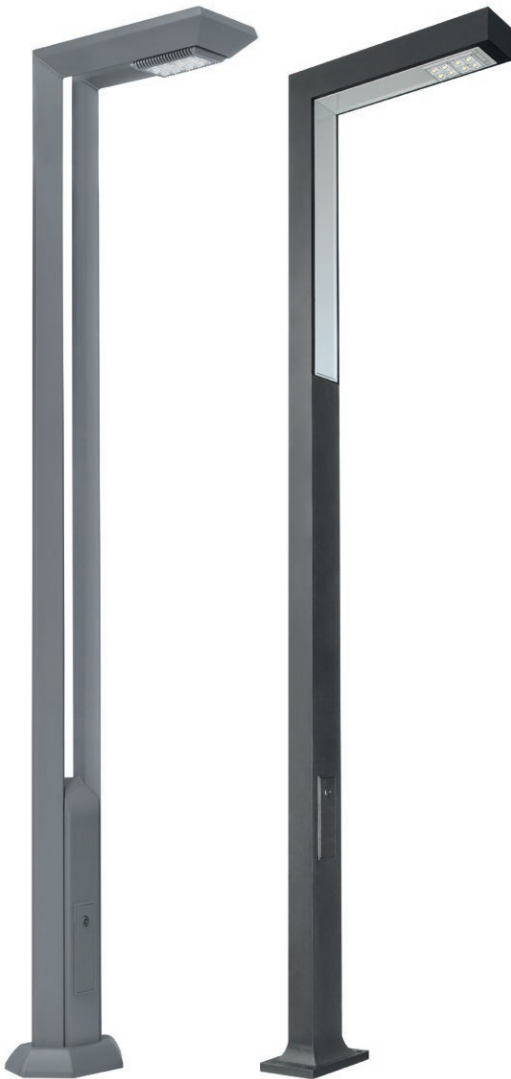

Code	BTL50	BKL50
LED	High Efficiency Power LEDs	
System Power	52W	
Light Flux	5.180lm	
Colour Temperature	4000 - 5000 - 6500 K	
Voltage	220V - 50Hz	
Body	Aluminum	
Cooler	Cooling from the surface of the aluminum body	
Diffuser	Glass	
Colour	Grey, black or white	

Floodlights

HERCULED

IP66



HCL/B

BASIC



HCL/P

POWER



HCL/PRO

Herculed projectors are made for outdoor use. They can also be used as white, red, green, blue, yellow or RGB. With Litpa's exclusive DMX system, it is possible to open and close many luminaires from a single point, to dim, to manage different scenarios. Litpa uses light fittings that are fully compatible with the LED structure in these luminaires, allowing the light to reach only the desired area without loss.

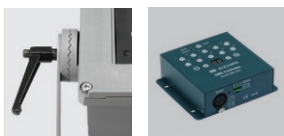
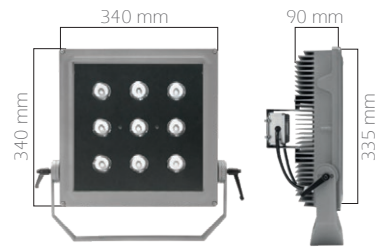

Adjustable angle

DMX Controller

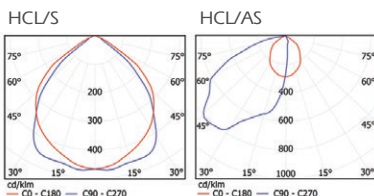
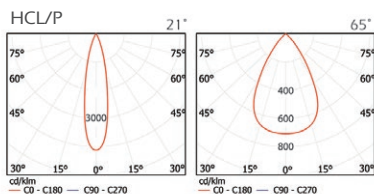

Code	HCL/B	HCL/P	HCL/PRO
LED	High Efficiency Power Led	High Efficiency Multi-Power	High Efficiency Multi-Power
System Power	45 W 65 W 90 W 135 W	80 W (3x3) 137 W (4x4) 185 W (5x5)	65 W 130 W 210 W
Light Flux	4,480 lm 6,800 lm 8,960 lm 12,600 lm	6,800 lm 12,000 lm 15,750 lm	RGBW
Color Temperature	3000-4000 5000K-RGB R-G-B-A	3000-4000 5000K- R-G-B-A	RGBW
Voltage	220V - 50Hz		
Body	Aluminum injection		
Diffuser	Tempered glass		
Optic	12° - 25°- 61° High efficiency lens	21° - 45°- 65° High efficiency lens	9° - 28°- (42°+30°) High efficiency
Box Dimensions	44x48x19cm	44x48x19cm	44x48x19cm
Weight	12.000 gr	12.100 gr	12.000 gr





# HERCULED

IP66



HCL/SP SUPER POWER



HCL/S (Symmetrical) AREA



HCL/ST



HCL/AS (Asymmetrical)



Adjustable angle

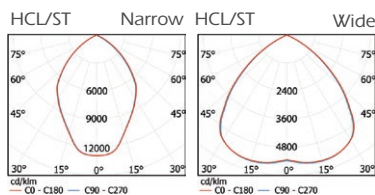
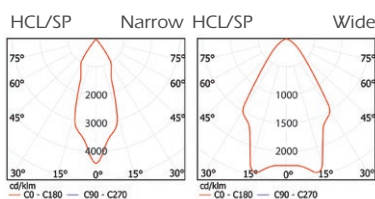
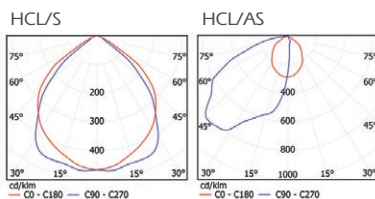

To be able to meet the needs perfectly in field and field lighting in order to develop different optical structures by Litpa. In the standard field illumination, the optical structure of the Herculed / Area model is symmetrical and asymmetrical. On facades and more sensitive lighting Herculed Super Power meets all kinds of lighting needs.

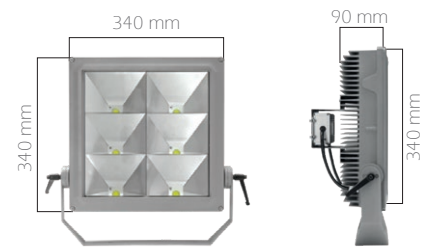

Code	HCL/SP	HCL/S HCL/AS	HCL/ST
LED	High Efficiency Multi-Power	High Efficiency COB Led	High Efficiency Mid Power
System Power	200 W 225 W 250 W 275 W	65 W 92 W 110 W 185 W	100 W 150 W 200 W 250 W
Light Flux	19,000 lm 20,200 lm 23,400 lm 25,500 lm	7,000 lm 10,300 lm 12,400 lm 20,800 lm	14.200 lm 20.000 lm 27.500 lm 29.000 lm
Color Temperature	3000 K 4000 K 5000 K	3000 K 4000 K 5000 K	3000 K 4000 K 5000 K
Voltage	220V - 50Hz		
Body	Aluminum injection		
Diffuser	Tempered glass		
Optic	Narrow-Wide Angle Reflector	Miro-Silver Aluminum	Miro-Silver Aluminum
Box Dimensions	44x48x19cm	44x48x19cm	44x48x19cm
Weight	12.000 gr	12.100 gr	12.000 gr



Rotational Floodlights

RTL

IP65



RTL 24

RTL projectors are manufactured with optical structure which can provide light from 10 ° to 60 ° in lighting of columns and wall surfaces. LEDs in white, red, green, blue and RGB colors are used and it is possible put on and off, dim and manage many fixtures with different scenarios from a single point by the DMX system specially produced by Litpa.

Projectors increase the efficiency in projects to the highest level with different power options. Mounting feet which can move gradually in low angle are designed to direct the fixture to the areas where focusing will be made. Aluminum body is painted to be resistant to the corrosive effects caused by the external environment conditions.



RTL 18

RTL 12

RTL 9



Louvre 1

Louvre 2



DMX Controller

RTL 9 - 12

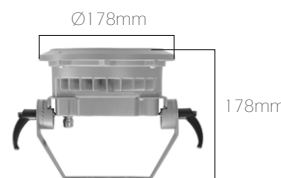

RTL 18 - 24

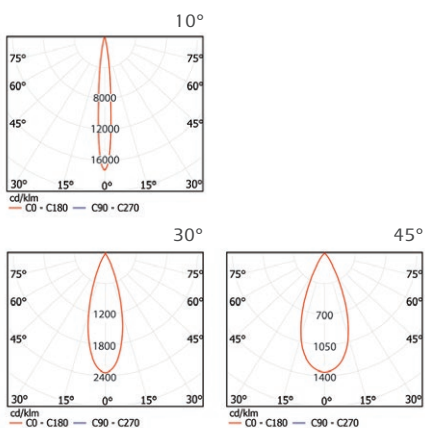
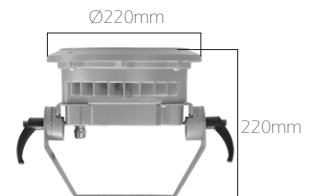

Code	RTL 9	RTL 12	RTL 18	RTL 24	
LED	High Efficiency Mid-Power LED				
System Power	12 W	15 W	22 W	28 W	40 W
Light Flux	1,145lm-30°	1,420lm-30°	2,300lm-15°	3,300lm-15°	4,290lm-15°
Colour Temperature	3000-4000-5000K, R-G-B-Amber, RGB				
Voltage	220V - 50Hz				
Body	Aluminum injection painted with electrostatic paint				
Cooler	Cooling from the body surface				
Optic	Impact resistance tempered glass and high efficient lenses				
Frame	Aluminum injection				
Colour	Grey				
Accessory	Standard cable or IP68 connector				
Box Dimensions	25x19x17cm		28x23x17cm		
Weight	2.500 gr	2.600 gr	3.100 gr	3.200 gr	

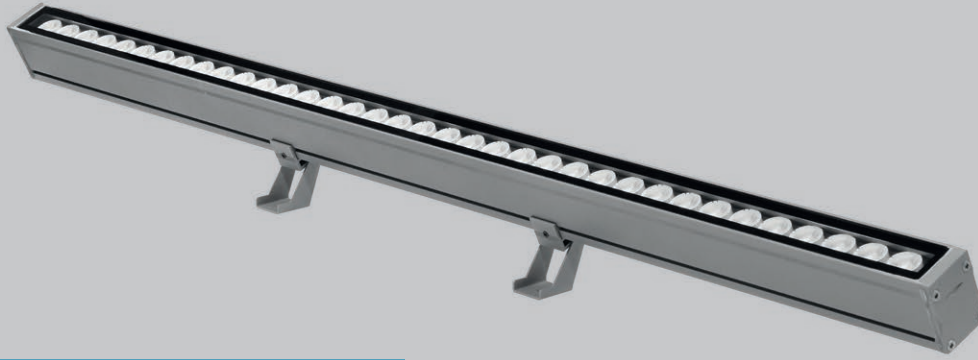

## Wallwasher

## SKYLINE

IP65



Wallwasher type SKYLINE fixture which is an indispensable fixture of facade lighting does not harm the aesthetic appearance of the facade thanks to the slim and elegant structure thereof. The foot structure which moves along the fixture provides ease of installation while fixture efficiency is at the highest level thanks to powerful LEDs and lenses with high permeability.



LSW/RGB



DMX Controller

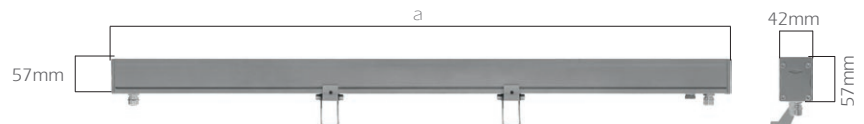

Code	a
LSW 50	510 mm
LSW 100	1.010 mm

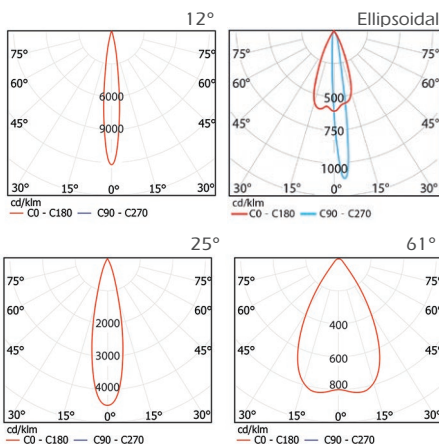

Code	LSW 50	LSW 100
LED	High Efficiency Power LED	
System Power	21 W	39 W
Light Flux	1,850 lm	3,400 lm
Colour Temperature	3000 - 4000 - 5000 K / R-G-B / RGB	
Voltage	220V - 50Hz	
Body	Aluminum extrusion	
Cooler	Cooling from the body surface	
Lens Angle	12° - (14°+39°) - 25° - 46° - 61°	
Diffuser	4mm thick and tempered, ground with serigraphic printing	
Optic	High efficient lenses	
Colour	Grey	
Accessory	Standard cable or IP68 connector	
Box Dimensions	52x5x11 cm	102x5x11 cm
Weight	1.550 gr	2.500 gr



# LITPA QUANTUM - Large

IP66



OTM-L

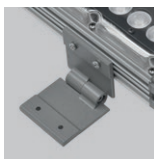

Adjustable Mounting Bracket

Litpa Quantum is a wallwasher type of fixture produced for use in facade lighting. They can be used as white, red, green, blue, yellow and RGB to get the desired effect on the surface. DMX systems allow the realization of different scenarios for the fixture from one single center. It is possible to direct the area to light properly by virtue of the lens types that can be used at different angles.

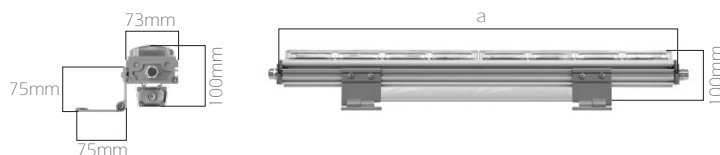
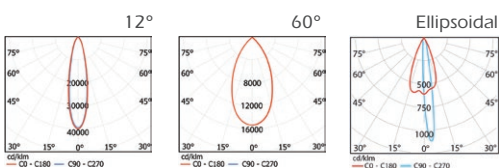

Code	a
OTM 30	320 mm
OTM 60	620 mm
OTM 90	920 mm
OTM 120	1.220 mm

Code	OTM/L30		OTM/L60		OTM/L90		OTM/L120	
LED Type	High efficiency Power LED							
LED Quantity	Single	RGB	Single	RGB	Single	RGB	Single	RGB
	24pcs	24pcs	48pcs	48pcs	72pcs	72pcs	96pcs	96pcs
System Power	26W	26W	52W	52W	75W	75W	100W	100W
Light Flux	3.390lm	-	7.030lm	-	10.200lm	-	13.600lm	-
LED Life	50.000hrs							
Body	Aluminum extrusion							
Cooler	Cooling from the body surface							
Diffuser	Polycarbonate							
Optic	High efficiency lens							
Lens Angle	12° - 60° and Ellipsoidal							
Colour Temperature	3000K - 4000K - 5000K, red, blue, green, amber, RGB, RGBW, tunable white							
Accessory	Waterproof connector							
Weight	1.5kg		2.6kg		3.2kg		4.25kg	

Luminous flux measured at 4000K with 60° lens



Wallwasher

# LITPA QUANTUM - Slim

IP66



QTM/S



Opal Diffuser



Adjustable Mounting Bracket

Slim Series Litpa Quantum luminaires on the facade with subtle and elegant structures it provides optimum adaptation to the architectural structure by preserving itself. Foot structure can be adjusted at the desired angle. In this way, they can be assembled. Luminaires to be used with DMX systems suitable. Facade with color transitions using single and multiple colors or the desired effects can be provided in the environment.

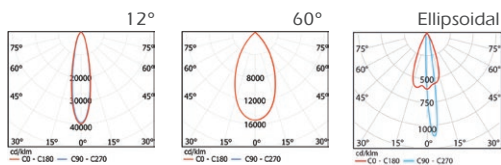
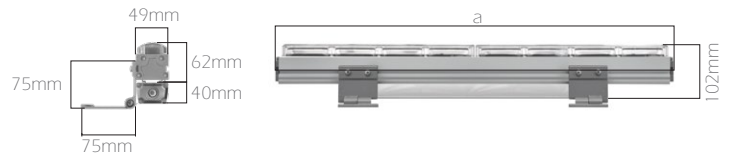

Code	a
QTM/S 30	320 mm
QTM/S 60	620 mm
QTM/S 90	920 mm
QTM/S 120	1.220 mm

Code	QTM/S30	QTM/S60	QTM/S90	QTM/S120
LED Type	High efficiency Power LED			
LED Quantity	12pcs	24pcs	36pcs	48pcs
System Power	14W	28W	40W	51W
Light Flux	1800lm	3600lm	5400lm	7180lm
LED Life	50.000hrs			
Body	Aluminum extrusion			
Cooler	Cooling from the body surface			
Diffuser	Polycarbonate			
Optic	High efficiency lens			
Lens Angle	12° - 60° and Ellipsoidal			
Colour Temperature	3000K - 4000K - 5000K, red, blue, green, amber			
Accessory	Waterproof connector			

Luminous flux measured at 4000K with 60° lens



Ground Recessed

# HADES

IP67

Ground recessed fixture series named HADES fixtures are designed for use in interior and exterior spaces and are extremely efficient fixtures for lighting of facades, walls, columns, and trees. High efficiency LEDs increase the life of the fixtures and eliminates the heating problems.

These fixtures are resistant to shock thanks to especially reinforced glass structures thereof. They can be produced in desired light color temperature and in different light colors. They are able to create the desired aesthetic effect in the area by being connected to the DMX control unit and by using as RGB.



HYL 9



HYL 12



HYL 18



HYL 24

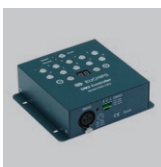

DMX Controller



HYL OP

HYL 9 - 12



HYL 18 - 24

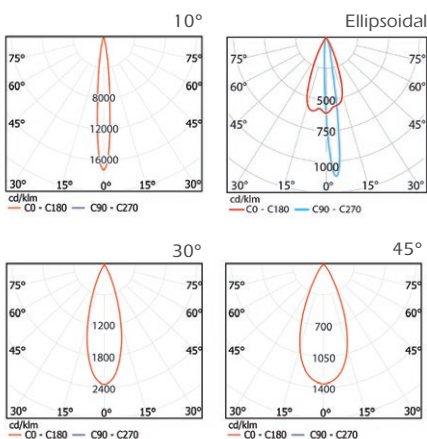

Code	HYL 9	HYL 12	HYL 18	HYL 24
LED	High Efficiency Power LED			
System Power	12 W	15 W	22 W	28 W
Light Flux	1,050 lm	1,411 lm	2,300 lm	3,300 lm
Colour Temperature	3000-4000-5000-6500 K, R-G-B-Amber, RGB			
Voltage	220V - 50Hz			
Body	Aluminum injection			
Frame	Type 304 Stainless steel			
Cooler	Cooling from the body surface			
Lens Angle	10° - (14°+39°) - 30° - 45°			
Optic	Impact resistance tempered glass and high efficient lenses			
Accessory	Standard cable or IP68 connector			
Box Dimensions	26x26x25cm		32x32x27cm	
Weight	2.500gr	2.600gr	3.200gr	3.300gr

## Ground Recessed

YLW

IP67



These highly efficient linear fixtures can be used as ground recessed fixtures in interior and exterior lighting. They have a long lifetime thanks to their stainless steel frames, highly resistant heat-treated glasses and corrosion resistant aluminum bodies that can transfer heat easily. Different LEDs can create the color temperature of the light generated in the fixture. They can be used as RGB by connecting to the DMX control unit.



DMX Controller

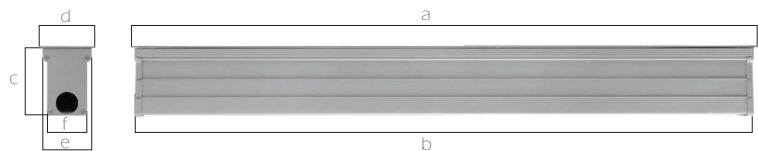

Code	a	b	c	d	e	f	Cut-Out
YLW 40	402 mm	390 mm	107 mm	90 mm	80 mm	65 mm	82X395mm
YLW 70	562 mm	550 mm	107 mm	90 mm	80 mm	65 mm	82X555mm
YLW 100	1058 mm	1046 mm	107 mm	90 mm	80 mm	65 mm	82X1050mm

Code	YLW 40	YLW 70	YLW 100
LED	High Efficiency Power LED		
System Power	10 W	21 W	39 W
Light Flux	1.050 lm	2.200 lm	4.050 lm
Colour Temperature	3000-4000-5000-6500K, R-G-B-Amber, RGB		
Voltage	220V - 50Hz		
Body	Aluminum extrusion		
Cooler	Cooling from the aluminum body surface		
Lens Angle	12° - (14°+39°) - 25° - 46° - 61°		
Diffuser	Impact resistance tempered glass with 8mm thickness		
Optic	High efficient lenses		
Frame	Type 304 stainless steel		
Accessory	Standard cable or IP68 connector		
Box Dimensions	42x12x10 cm	58x12x10 cm	108x12x10 cm
Weight	2.230 gr	3.350 gr	6.250 gr

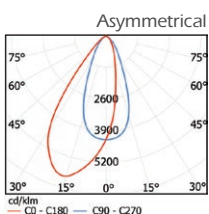

Garden Lighting



D-LFA / D-LFB

IP65

Special lighting system designed with high efficiency LED technology within range of 4 to 12 W for outdoor applications. Can also be employed in architectural garden lighting, tree lighting and for highlighting details.

Durability in all kinds of outdoor conditions thanks to corrosion-resistant cast aluminum outer body thereof. Two different types of mounting options are offered. The models include the type with foot anchored to the ground and the type with foot driven into the ground.



D-LFB9



D-LFK9



D-LFA4



D-LFK4



D-LFA3



D-LFK3

D- LFA3 / D-LFA4



D- LFA3 and D- LFA4 dimensions are the same.

D- LFK4

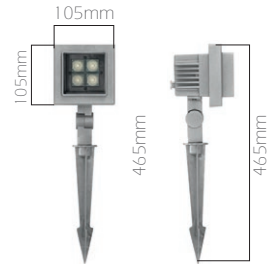

D- LFB9

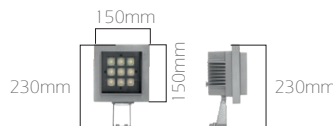

D- LFK9

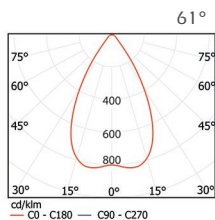
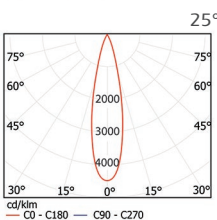
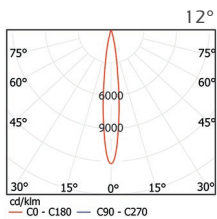
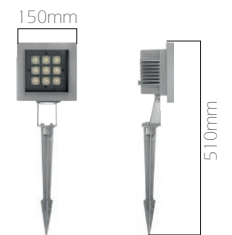

Code	D-LFA3 / D-LFK3	D-LFA4 / D-LFK4	D-LFB9 / D-LFK9
LED	High Efficiency Power LED		
System Power	4 W	5,5 W	12 W
Light Flux	400 lm	500 lm	1200 lm
Colour Temperature	3000 - 4000 - 5000 K, R-G-B - Amber		
Voltage	220V - 50Hz		
Body	Aluminum injection painted with electrostatic paint		
Cooler	Cooling from the body surface		
Lens Angle	12°, 25°, 29°, 61° Lens		
Glass	3 mm thickness tempered		
Colour	Grey		
Box Dimensions	15x15x20cm 15x15x30cm	15x15x20cm 15x15x30cm	18x18x25cm
Weight	800 gr	800 gr	1.590 gr





## Flowers / Grass Lighting

### MSH

### IP65



Special indirect lawn and garden lighting system designed with high efficiency LED technology within range of 3 to 9 W for outdoor applications. The system is preferred in architectural applications generally thanks to the indirect light beam coming from the module. Bright white paint with reflective properties has been used in the interior body paint with an eye to benefit maximum from the light coming from the LED modules.

MSH model Grass Fixtures can be employed for lighting lawn and garden plants and highlighting details in architectural garden lighting. Color options are available with a view to provide different light effects. Length of the fixture can be arranged according to the desired height.

Durability in all kinds of outdoor conditions thanks to corrosion-resistant injection molded aluminum outer body thereof. Has a long life by virtue of the injection molded aluminum with IP65 protection degree and does not require maintenance thanks to the LED module thereof. It can provide different applications with its free standing model and with the model which can be driven into the ground.

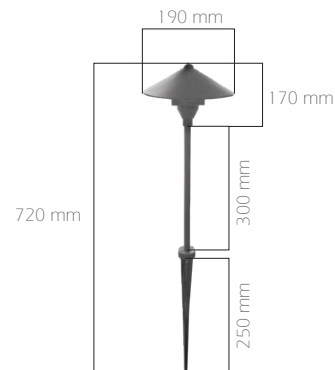

Code	MSH
LED	High Efficiency Power LED
System Power	4,5 W
Light Flux	75 lm
Colour Temperature	3000 - 4000 - 5000 K / R-G-B
Voltage	220V - 50Hz
Body	Aluminum injection LED moduls
Lens	Lenses with opal diffuser effect
Glass	3 mm thick and tempered glass
Colour	Grey



Bollard - Globe

# BOLLARD

IP54

Our bollards are preferred in various areas of application such as lighting of walking trails, parks, recreational areas, residential areas, outside the stadiums and etc.

Highly efficient LED systems have been used in this product like in all of our LED products. System power is within the range of 15 W to 22 W and the product life has been extended by easy installation and maintenance.



8040



8050



CB10



3007

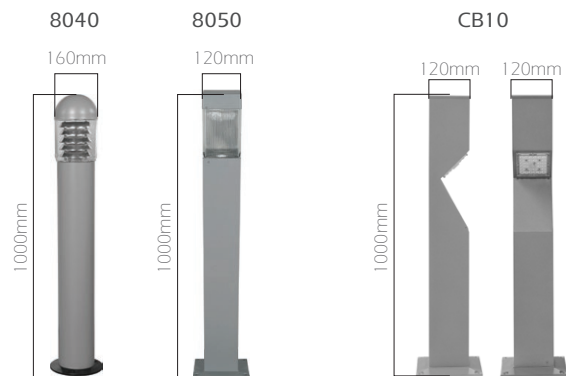

CB10 TOP VIEW



Code	8040	8050	CB10	3007
LED	High Efficiency Mid-Power LED			
System Power	15 ~ 22 W		12W	15-22W
Light Flux	700 ~ 1000 lm		1300lm	700 ~ 1000 lm
Colour Temperature	3000 - 4000 - 5000 K - R-G-B			
Voltage	220V - 50Hz			
Body	Aluminum			Aluminum pipe
Diffuser	Opal or Prismatic			Opal
Box Dimensions	21x21x104 cm			51x51x52 cm
Weight	5,200 gr			2,650 gr

### D-LWD

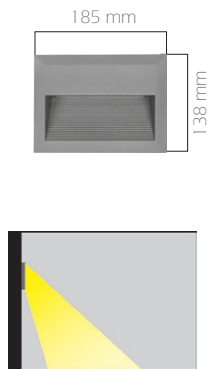

Blind Casing Dimensions:  
174 x 130 x 84 mm

IP65

Code	D-LWD
LED	High Efficiency Mid-Power LED
System Power	7 W
Colour Temperature	3000 - 4000 - 5000 K
Voltage	220V - 50Hz
Body	Aluminum injection
Diffuser	2 mm acrylic lens
Colour	Grey
Box Dimensions	19x14x100 cm
Weight	1.000gr

### D-LYD



IP65

Code	D-LYD
LED	High Efficiency Mid-Power and COB
System Power	5W
Colour Temperature	3000 - 4000 - 5000 - 6500 K, RGB
Voltage	220V - 50Hz
Body	Aluminum injection
Lens	Opal
Cooler	Cooling from the body surface
Colour	Grey
Box Dimensions	13x15x12 cm
Weight	450 gr

### D-LSD

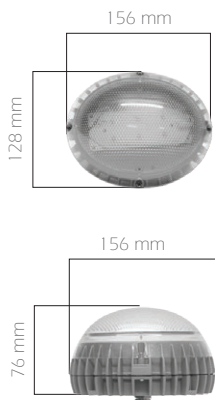

IP65

Code	D-LSD
LED	High Efficiency Mid-Power Led
System Power	8 W
Colour Temperature	3000 - 4000 - 5000 - 6500 K
Voltage	220V - 50Hz
Body	Aluminum injection
Diffuser	Acrylic transparent lens
Cooler	Cooling from the body surface
Colour	Grey
Box Dimensions	13x15x18 cm
Weight	650 gr



## Canopy Luminaires

# PETROLED

IP65

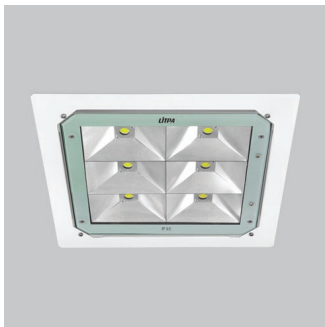

PTL/S

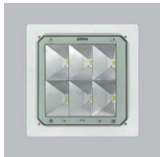

PTL/AS

PETROLED Series fixtures produced as canopy fixtures and which can be used under fringes are robust fixtures and are resistant against exterior ambient conditions with durable die-cast aluminum body. The desired light distribution is ensured while maintaining high optical yield at the same time thanks to Miro-Silver reflectors made from material produced especially for LEDs by the German company named Alanod. Fixtures can be produced symmetrical or asymmetrical according to requirement.

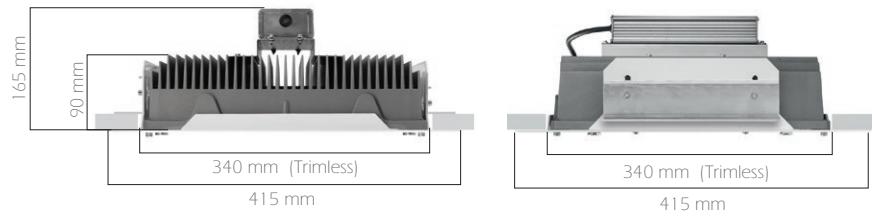

PTL/S

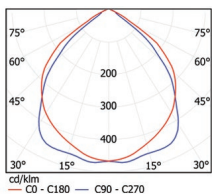

PTL/AS

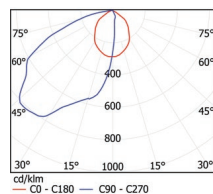

Code	PTL 40/S PTL 40/AS	PTL 60/S PTL 60/AS	PTL 100/S PTL 100/AS
LED	High Efficiency COB LED		
System Power	35 W	60 W	100 W
Light Flux	4.000lm	6.000 lm	10.000 lm
Colour Temperature	3000 - 4000 - 5000 K		
Voltage	220 Volt - 50 Hz		
Body	Aluminum injection		
Diffuser	Impact resistance tempered glass serigraphic printing		
Reflector	Alanod brand vacuum anodized Miro -Silver aluminum		
Cooler	Cooling from the Al. body surface		
Colour	White		
Accessory	Recessed ceiling apparatus		
Box Dimensions	43x43x17 cm		
Weight	11.100 gr		



## Tunnel Lighting

### HCL-T

IP66

Litpa Tunnel Luminaires have produced high quality optic with high technology. It presents excellent technical lighting conditions of tunnel luminaires. Dust and water-resistant body structure and extremely high corrosion resistance. it provides a long life with. Thanks to the aluminium body structure provides well-ordered cooling.

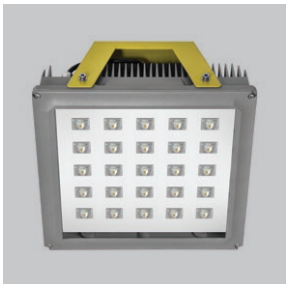

HCL/T BASIC

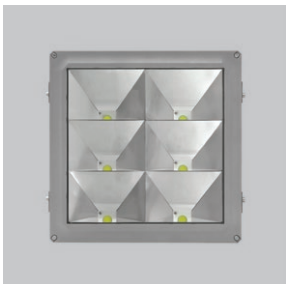

HCL/T STANDARD

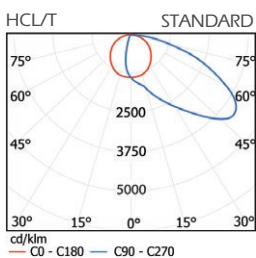
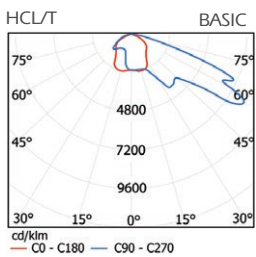
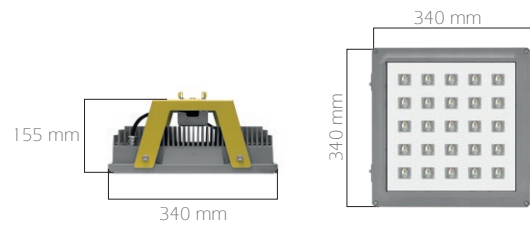

	BASIC		STANDARD		
Code	HCL/T80	HCL/T150	HCL/T100	HCL/T150	HCL/T200
LED	High Power LED				
Sytem Power	80 W	150 W	100 W	150 W	200 W
Light Flux	8.900lm	13.900lm	12.950lm	19.250lm	25.000lm
Color Temperature	3000-4000-5000K				
Voltage	220V - 50Hz				
Body	Aluminum injection				
Glass	Impact resistance tempered glass				
Optic	High efficiency lens				
Weight	13.000 gr				

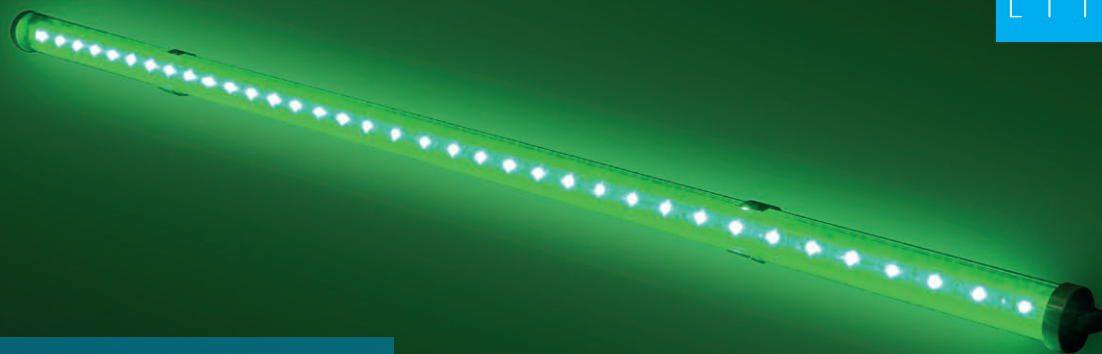

Led Tube

## LDD



Mounting brackets are optional  
Adjustable mounting accessories provides angle based mounting option  
LDD fixture is convenient for double side light effect applications  
Wide range of length option from 50cm to 120cm  
Wide range of colour temperature option from 2700K to 6500K  
Colour Rendering index CRI > 80  
Offer best solution for linear applications and provides homogenous light effect  
Multiple fixture can be controlled by one ballast vary up to 240W power consumption at the linear effect applications  
Red-Green-Blue, RGB option is available

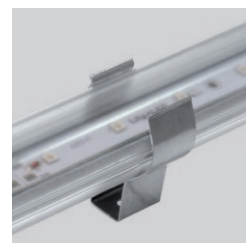

Ease of installation



IP67 Connector

## IP66

Led Tube luminaires with high protection class (IP) ratings are the essential elements of outdoor lighting. They are often preferred because of the fact that they do not create an unwanted image on a continuous straight line on the façade. LDD luminaire is convenient for facade lighting and offers lighting effects for roof eaves hidden niches. Litpa LDD Led Tubes fulfill the functions of operating without any problems in a long lifetime, thanks to high lumen values and quality components used in production.

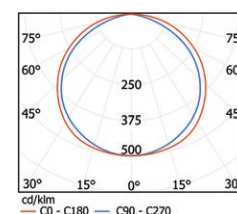

Code	LDD
LED	High Efficiency Midpower LED
System Power	18W/m
Light Flux	1533 lm/m
Colour Temperature	3000 - 4000 - 5000 K, R,G,B -RGB
Voltage	220V - 50Hz
Body	Acrylic body and end caps
Colour	Transparent body, gray end caps
Weight	250gr

# INDOOR LIGHTING LUMINAIRES





Downlight

# SHOPLED

IP20

High energy-efficient SHOPLED downlight fixtures can be used in many areas with the large usage area thereof including shops, hotels, restaurants, cafés, educational areas hospital and houses. They can meet the investment in the usage area after a very short time even with the change of the existing systems. The lives of used COB LEDs are very long due to their fixture bodies and the aluminum coolers placed thereon.



SLG 104



SLG 160

SLG 165



SLG 195

SLG 200

SLG 104

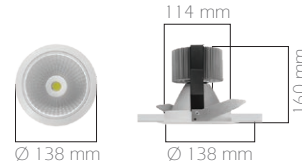

SLG 160 - SLG 165

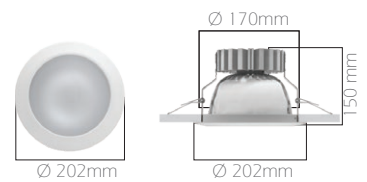

SLG 195 - SLG 200

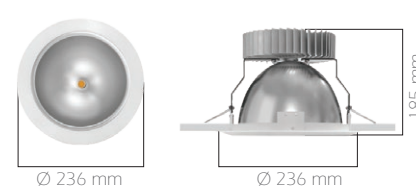

Code	Cut-Out
SLG 104	120 mm
SLG 160	172 mm
SLG 165	172 mm
SLG 195	205 mm
SLG 200	205 mm

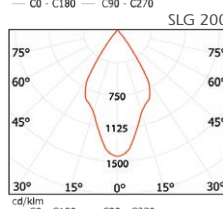
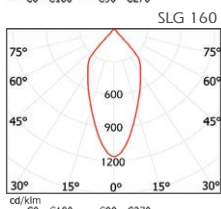
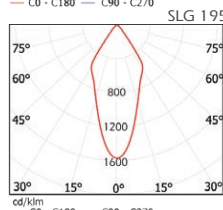
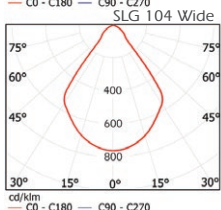
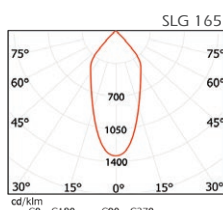
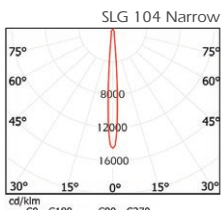

Code	SLG 104	SLG 165 SLG 160	SLG 195 SLG 200
LED	High Efficiency COB LED		
LED Power	13 W	27 W	36 W
Light Flux	1,280 lm	2,560 lm 2,300 lm	3,300 lm 3,000 lm
Colour Temperature	3000 - 4000 - 5000 K		
Voltage	220V - 50Hz		
Body	Die-cast aluminum frame painted with 80 micron thick		
Reflector	99% pure aluminum		
Diffuser	Acrylic diffuser or tempered glass		
Cooler	Aluminum extrusion		
Colour	White		
Box Dimensions	30x44x21 cm(6pcs)	47x47x18 cm(4pcs) 21x23x18 cm(1 pcs)	25x26x24 cm(1 pcs) 26x26x25 cm(1 pcs)
Weight	4.400 gr(6pcs)	5.250gr(4pcs) 1.350gr(1 pcs)	1.800 gr(1 pcs) 1.650 gr(1 pcs)



## Downlight

## PUNTO

IP20  
IP40 Optional

High permeability opal diffuser transfers light to the environment in soft a way. High lighting efficiency and a clear appearance is achieved thanks to special reflectors used in the inner side surface of the fixture. Affordability, efficiency and slimness are three words that summarize Punto Series downlights best.



SSL 104



SSL 160

SSL 200



SSL 235

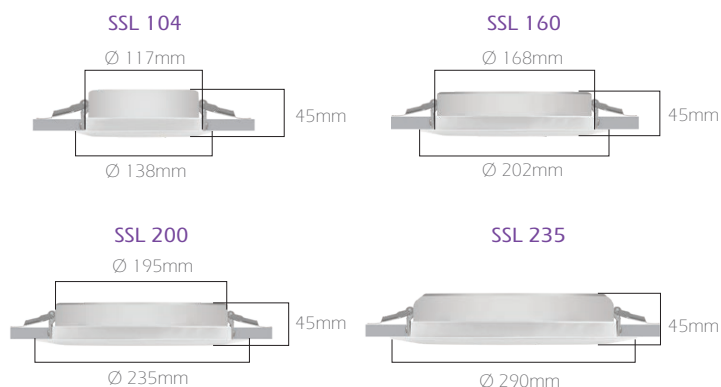

Code	Cut-Out
SSL 104	120 mm
SSL 160	172 mm
SSL 200	205 mm
SSL 235	245 mm

Code	SSL 104	SSL 160	SSL 200	SSL 235
LED	High Efficiency Mid-Power LED			
LED Power	13 W	18 W	23 W	32 W
Light Flux	776 lm	1,500 lm	1,880 lm	2,300 lm
Colour Temperature	3000 - 4000 - 5000 K			
Voltage	220V - 50Hz			
Body	Aluminum injection frame.			
Diffuser	Opal			
Cooler	Cooling from the body surface			
Colour	White			
Box Dimensions	15x15x7cm	22x22x7cm	25x25x7cm	30x30x7cm
Weight	250 gr	450 gr	450 gr	550 gr

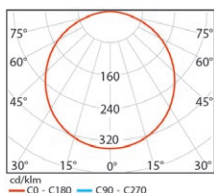



Downlight

FASHIONLED

IP20



FASHIONLED is type of fixture which can be easily used in a practical manner thanks to the design thereof allowing it to be moved and turned to all directions easily by mounting on rails in case of need for store, shop window and emphasized lighting. Multiple blades placed thereon transfers the cooling area from an extremely large surface to environment. Thus, highly efficient COB LEDs can have a very long life. Reflector options with 10 °, 30 ° and 60 ° are available. A wide choice is offered to users with different strengths and body structures.

RLK 13



RLK 27



RPL 13

RPL 27

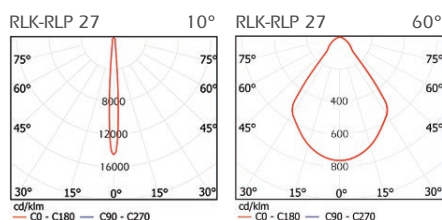
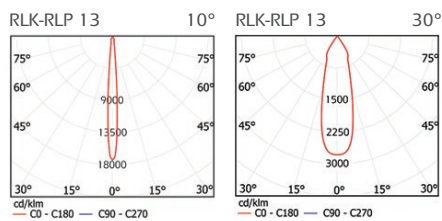
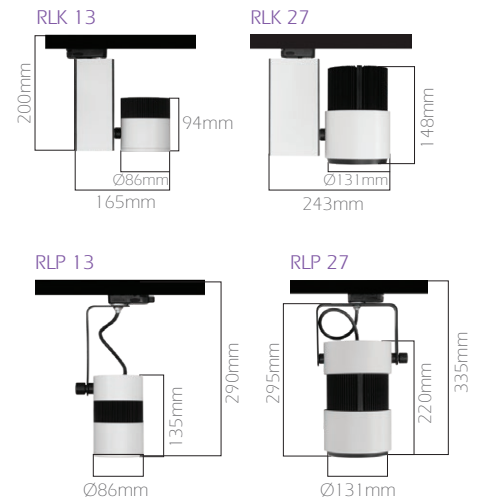

Code	RLK 13	RPL 13	RLK 27	RPL 27
LED	High Efficiency COB LED			
LED Power	13 W		27 W	
Light Flux	1,350 lm		2.500 lm	
Colour Temperature	3000 - 4000 - 5000 K			
Voltage	220V - 50Hz			
Body	Aluminum extrusion and aluminum frame			
Reflector	99% pure aluminum			
Diffuser	3 mm thickness transparent tempered glass			
Cooler	Aluminum extrusion			
Colour	White			
Box Dimensions	22x17x29 cm		25x25x40 cm	
Weight	900 gr		2.700 gr	

## Downlight



## FASHIONLED

IP20

RLK / M series luminaires which are including lens produced with aluminum body provide the desired optical requirements for the spaces, while they attract attention as highly efficient rail spots. Luminaires are compact body, easily orientable and mountable luminaire. Luminaires are manufactured with quality material and simple design concept.



RLK/M

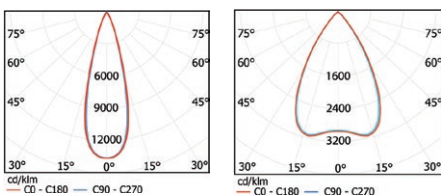
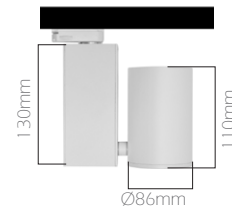

Code	RLK/M
LED	High Efficiency LED
System Power	32 W
Light Flux	3.350 lm
Colour Temperature	3000 - 4000 - 5000 K
Voltage	220V - 50Hz
Body	Aluminum extrusion and aluminum frame
Reflector	99% Pure aluminum
Optic	Ledil Lens
Colour	White



DML 1



DML 2



DML 3



DML 4

Downlight

SHOWLED

IP20



SHOWLED is a highly efficient and economical type fixture with a wide range of applications used in interior. Spots in 2, 3 and 4-piece units are designed to meet independently from each other. In this way, light from a single fixture can be transmitted simultaneously to different directions.

Mounting feet press firmly on the surface to prevent the gap between ceiling and the mounting frame and bad appearance due to assembly can be prevented. Different reflector structures offer possibilities to meet your requirements from the optical point of view. High LED efficiency and highly efficient reflectors thereof will provide significant energy savings for your business.

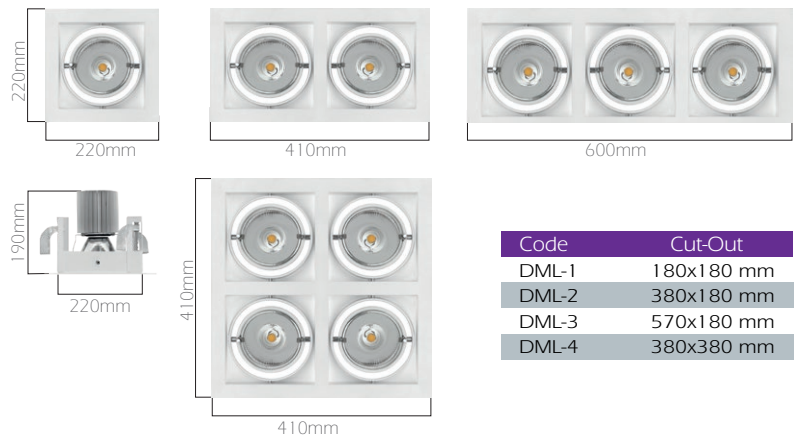

Code	Cut-Out
DML-1	180x180 mm
DML-2	380x180 mm
DML-3	570x180 mm
DML-4	380x380 mm

Code	DML 1	DML 2	DML 3	DML 4
LED	High Efficiency COB LED			
LED Power	1x13 W 1x27 W 1x36 W	2x13 W 2x27 W 2x36 W	3x13 W 3x27 W 3x36 W	4x13 W 4x27 W 4x36 W
Light Flux	1,350 lm 2,650 lm 3,350 lm	2,700 lm 5,300 lm 6,700 lm	4,050 lm 7,950 lm 10,050 lm	5,400 lm 10,600 lm 13,400 lm
Colour Temperature	3000 - 4000 - 5000 K			
Voltage	220V - 50Hz			
Body	Made of 1 mm thick sheet steel and painted with powder paint			
Reflector	1 mm thick anodized aluminum vacuum 99.9 %			
Cooler	6063 T5 aluminum extrusion			
Colour	Grey			
Box Dimensions	24x24x21cm	24x45x21cm	24x64x21cm	45x45x21cm
Weight	2.100 gr	4.100 gr	6.200 gr	8.200 gr

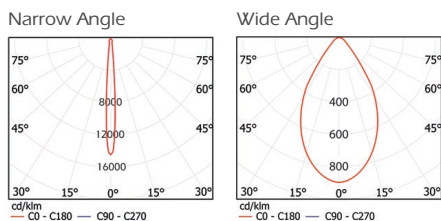

## Downlight

## GALAXYLED

IP20



DL 2003

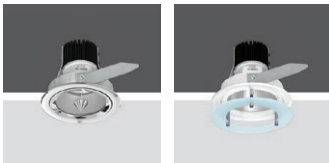

DL 2004

DL 2005



DL 2006

GALAXYLED fixtures are suitable for use in many areas such as particularly hotels, restaurants, plazas, shopping malls and stores. COB LEDs furnish extremely good fixture efficiency and stable operation by virtue of high-efficient reflectors and coolers manufactured from aluminum material with high-grade heat transfer. They lower the amount of visual pollution to minimum levels and help you to achieve the desired lighting levels. They are suitable for effects and decorative lighting with different optical and power options.

DL 2003-2004-2005-2006

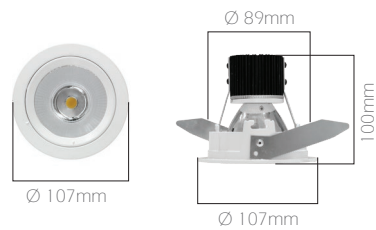

Code	Cut-Out
DL-2003	Ø 93 mm
DL-2004	Ø 93 mm
DL-2005	Ø 93 mm
DL-2006	Ø 93 mm

DL 2003-C1

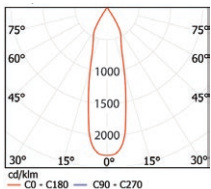

DL 2003-C2

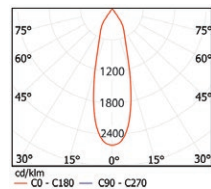

DL 2004

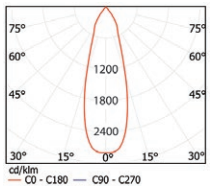

DL 2005

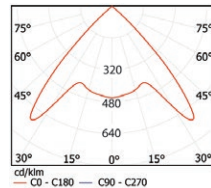

DL 2006

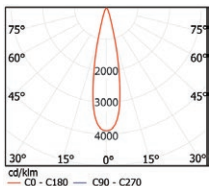

Code	DL 2003 C1 DL 2003 C2	DL 2004	DL 2005	DL 2006
LED	High Efficiency COB LED			
System Power	5.5 W	5.5 W	5.5 W	5.5 W
Light Flux	462 lm 438 lm	426 lm	465 lm	516 lm
Colour Temperature	3000 - 4000 - 5000 K			
Cooler	Aluminum extrusion			
Voltage	220V - 50Hz			
Body	Aluminum injection frame			
Reflector	High pure aluminum			
Diffuser	65 mm diameter 3 mm thick transparent tempered glass			
Colour	White			
Box Dimensions	15x15x12.5 cm			15x15x13cm
Weight	490 gr	500 gr	550 gr	480 gr 600 gr



Downlight

# SFR

IP20

SFR model downlight fixtures are indispensable application elements for interior lighting with their compact and simple structure. They can be applied in hotels, schools, shopping centers and many other places. Reflectors used in the fixture to perform this task without requiring extra frame and provide an appearance integrated with the ceiling and which does not harm the aesthetics structure of the area thanks to the fine structure thereof. They offer a perfect solution in locations where dark light is desired and glare is unwanted by using black reflector.



SFR 13/S White

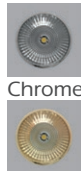

Chrome  
Gold



SFR 13/S

SFR 13/L

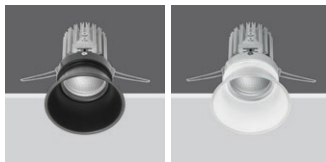

SFR 5 Black

SFR 5 White



SFR 8

SFR 13/S White

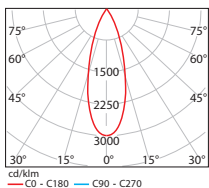

SFR 13/S Black

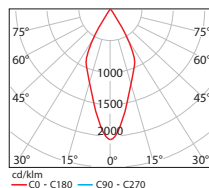

SFR 5 White

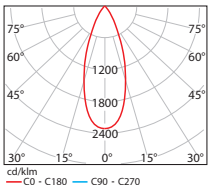

SFR 5 Black

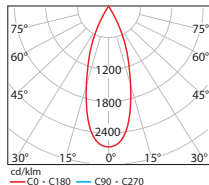

SFR5 - SFR8

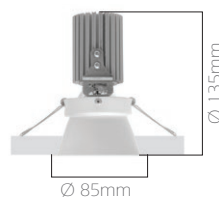

Ø 85mm



Ø 85mm

SFR 13/S

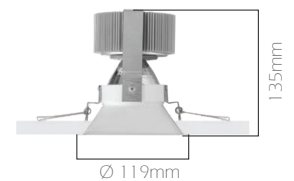

Ø 119mm



Ø 119mm

SFR 13/L



Ø 111mm

Code	Cut-Out
SFR 5	80 mm
SFR 8	80 mm
SFR 13/S	110 mm
SFR 13/L	105 mm

Code	SFR 5	SFR 8	SFR 13/S	SFR 13/L
LED	High Efficiency COB LED			
LED Power	5 W	8 W	13 W	13 W
Light Flux	350lm-Black Ref. 380lm-White Ref.	660lm-White Ref. -	708lm Black Ref. 833lm-White Ref.	833lm-White Ref. -
Colour Temperature	3000 - 4000 - 5000 K			
Voltage	220V - 50Hz			
Body	Manufactured from spinning aluminum and painted with 80 mm electrostatic powder paint			
Reflector	Spining aluminum			
Cooler	Aluminum extrusion			
Colour (Reflector)	White or Black			
Box Dimensions	10,5x10,5x10,5cm	10,5x10,5x15cm	14x13x13cm	16x13x13cm
Weight	250 gr	350 gr	450 gr	450 gr



## Downlight

### SMG-L

IP20



The SMG-L luminaires are perfectly matched to the ceiling with special pulley structure and show a nice posture in the ceilings with aesthetic durability in the applied areas. The orientation of the luminaire provides flexibility in positioning the ceiling. With the high efficiency LED types and power options used, desired lighting levels can be provided easily.



Ø 201 mm

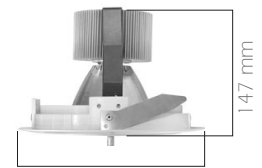

Ø 201 mm

147 mm

Narrow Angle

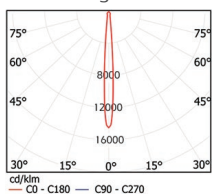

Wide Angle

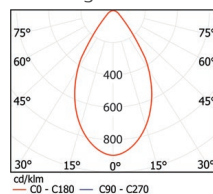

Code	SMG-L		
LED	High Efficiency COB LED		
LED Power	13 W	27 W	36 W
Light Flux	1.280 lm	2.500 lm	3.300 lm
Colour Temperature	3000 - 4000 - 5000 K		
Voltage	220V - 50Hz		
Body	Aluminum injection frame painted with 80 micron electrostatic powder paint		
Cooler	Aluminum extrusion		
Glass	3mm thick tempered glass		
Colour	White		
Box Dimensions	21x23x19 cm		
Weight	1.470 gr		



## Downlight Systems

### DR (Frames)

IP20

The LITPA Downlight systems ensure that different models and luminaire fittings can be used with different power options. Each type of pulley, the LED light source with 3 different wattage can be easily installed with the integrated cooler. There are options to use reflectors and lenses in luminaires. Thanks to the usage of optics, the light emitting from the luminaire is only and only directing to the enlightening areas. By this way energy conservation can be applied.



DR1 DR2 DR3 IP54



DR4 DR5 DR6



DR/7

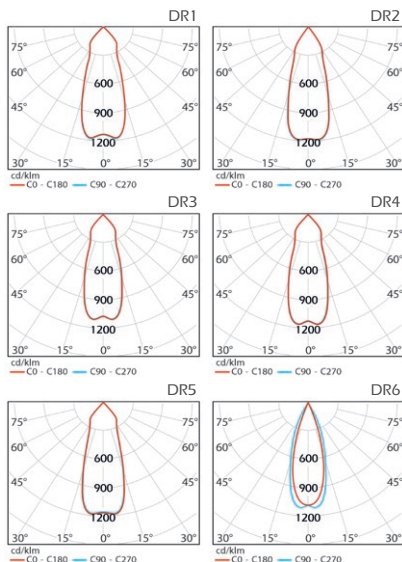

Code	DR1	DR2	DR3	DR4	DR5	DR6	DR7
LED	High efficiency LED						
System Power	4W 10W 15W	4W 10W 15W	4W 10W 15W	4W 10W 15W	4W 10W 15W	4W 10W 15W	4W 10W 15W
Light Flux	400lm 780lm 1170lm	350lm 650lm 980lm	360lm 690lm 1050lm	400lm 800lm 1200lm	380lm 750lm 1130lm	300lm 580lm 900lm	410lm 800lm 1200lm
Colour Temperature	3000 - 4000 - 5000 K						
Voltage	220V - 50Hz						
Body	Aluminum injection frame						
Optic	%99 pure aluminum or high efficiency lens						
Cooler	Aluminum injection						
Colour	White						





## Downlight Systems

### DOT (Power Options)

IP20



DOT1

DOT2



DOT3

### Optic



Lens

Reflector

### Accessories



This lighting system alone needs different visual, optical and light can be afforded. Some pulley types can be directed in vertical luminaire that permits. Anti-glare accessories can be applied to all pulley types.

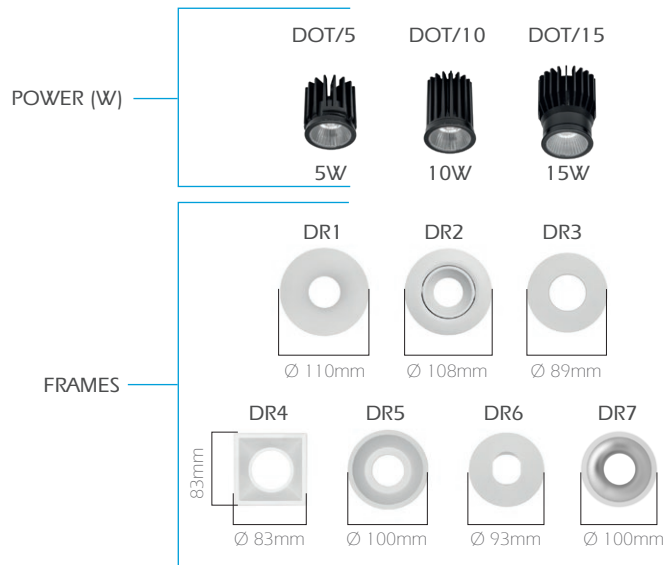

Frame	LUMINAIRE HEIGHT (h)			CUT-OUT
	POWER			
	DOT/5	DOT/10	DOT/15	
DR1	74mm	84mm	92mm	Frame: DR1 88mm
DR2	87mm	97mm	105mm	DR2 90mm
DR3	65mm	75mm	83mm	DR3 70mm
DR4	82mm	92mm	100mm	DR4 76x76mm
DR5	94mm	104mm	112mm	DR5 90mm
DR6	87mm	97mm	105mm	DR6 75mm
DR7	90mm	100mm	105mm	DR7 90mm

## ELD 75

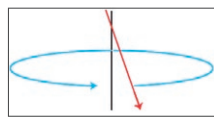

Rotatable



Ø 90mm

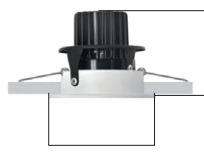

Ø 90mm

Ø 80mm

IP20

Code	ELD 75/5	ELD 75/8
LED	High Efficiency Power LED	
System Power	5 W	9,5 W
Light Flux	450 lm	850 lm
Colour Temperature	3000 - 4000 - 5000 K	
Voltage	220V - 50Hz	
Body	Aluminum injection	
Cooler	Aluminum	
Reflector	Aluminum	
Glass	3mm thick transparent tempered	
Box Dimensions	12x12x12 cm	
Weight	290 gr	
Cut-Out	Ø 75 mm	

## ELD 125

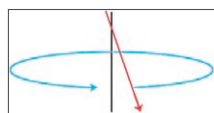
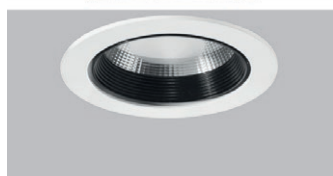
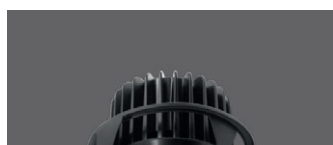

Rotatable



Ø 138mm



Ø 138mm

Ø 110mm

IP20

Code	ELD 125
LED	High Efficiency COB LED
System Power	16 W
Light Flux	1.060 lm
Colour Temperature	3000 - 4000 - 5000 K
Voltage	220V - 50Hz
Body	Aluminum injection
Cooler	Aluminum
Reflector	Aluminum
Glass	3mm thick transparent tempered
Box Dimensions	15x15x15 cm
Weight	740 gr
Cut-Out	Ø 125 mm

## ML 110

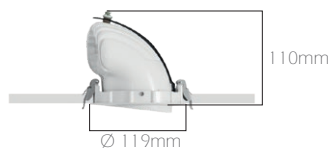
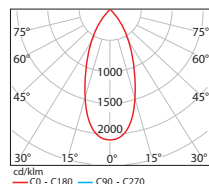

110mm

Ø 119mm

IP20

Code	ML 110
LED	High Efficiency COB LED
System Power	5 - 13, 27 W (active cooling)
Light Flux	480 - 1300 - 2760 lm
Colour Temperature	3000 - 4000 - 5000 K
Voltage	220V - 50Hz
Body	Aluminum injection
Reflector	Aluminum
Cooler	5-13W (passive), 27W (active cooling)
Diffuser	Tempered glass, transparent
Box Dimensions	16x16x15 cm
Weight	850 gr
Cut-Out	Ø 110 mm

## L1671

IP20 - IP54

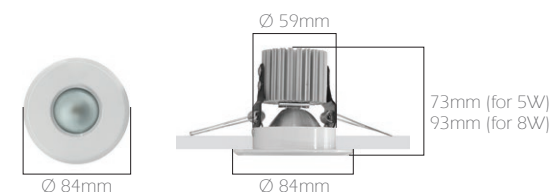
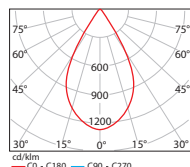
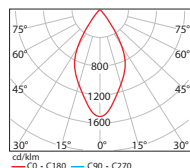

Code	L1671/5	L1671/8
LED	High Efficiency Multi-Power, COB LED	
System Power	5.5 W	8 W
Light Flux	480 lm	660 lm
Colour Temperature	3000 - 4000 - 5000 K	
Voltage	220V - 50Hz	
Body	Aluminum injection	
Reflector	99% pure aluminum	
Cooler	Aluminum extrusion	
Glass	3mm thick, transparent, tempered	
Box Dimensions	30x44x15 cm (6pcs)	
Weight	2.300 gr (6pcs)	
Cut-Out	Ø 68 mm	

## HRN1

IP20



Code	HRN113	HRN127	HRN213	HRN227
LED	High Efficiency COB LED			
LED Power	13,5 W	27 W	2x13,5 W	2x27 W
Light Flux	1.230 lm	2.350 lm	2.460 lm	4.700 lm
Colour Temperature	3000 - 4000 - 5000 K			
Voltage	220V - 50Hz			
Body	0,6 mm thick DKP			
Reflector	99.9 % purity aluminum			
Cooler	6063 T5 aluminum extrusions			
Colour	White, Black			

## HRN2

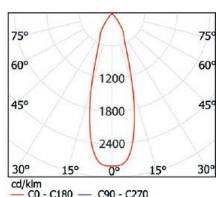

Code	h	a	b
HRN113	125mm	120mm	120mm
HRN127	140mm	120mm	120mm
HRN213	125mm	230mm	120mm
HRN227	140mm	230mm	120mm

LKG1

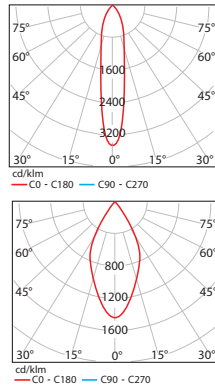

LKG2

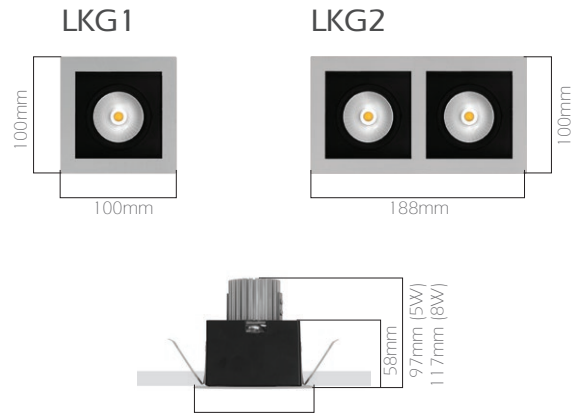
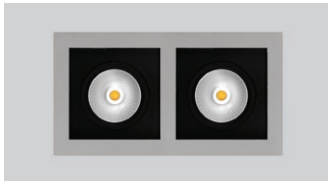

IP20

Code	LKG 1		LKG 2	
LED	High Efficiency LED			
System Power	5.5 W	8 W	2x5.5 W	2x8 W
Light Flux	480lm	660 lm	960 lm	1320 lm
Colour Temperature	3000 - 4000 - 5000 K			
Voltage	220V - 50Hz			
Body	1 mm thick DKP sheet painted with electro-static powder paint			
Reflector	High efficiency aluminum			
Cooler	Aluminum extrusion			
Frame	1,5mm thick DKP, inner frame aluminum injection			
Box Dimension	30x44x15 cm (6pcs)			
Weight	3.200 gr (6pcs)		5.500 gr (6pcs)	
Cut-Out	93X93 mm		93X181 mm	

LKG/M

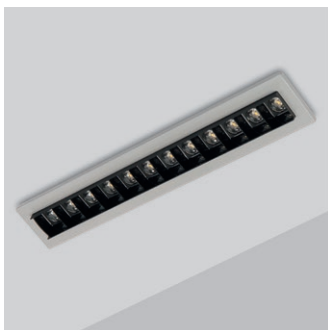

IP20

Code	LKG/M
LED	High Efficiency Power LED
System Power	15 - 25W
Light Flux	1.000 - 1.650 lm
Lens	Special 12pcs grid lens
Colour Temperature	3000 - 4000 - 5000 K
Voltage	220V - 50Hz
Body	0,6 mm thick DKP sheet and electrostatic powder paint
Frame	0,6mm thick DKP sheet steel
Reflector	High efficient aluminum
Colour	Gray
Cut-Out	38mm x 295 mm
Weight	1.200 gr



PGH

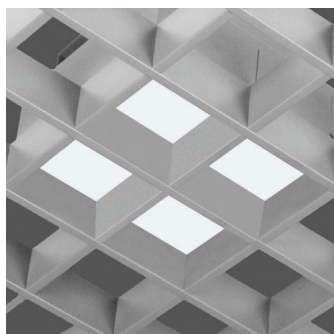

IP20

Code	PGH
LED	High Efficiency Mid-Power LED
System Power	10 W - 15 W - 20 W
Light Flux	840 lm - 1.170 lm - 1.230 lm
Colour Temperature	3000 - 4000 - 5000 K
Voltage	220V - 50Hz
Body	0.6mm made DKP steel sheet and painted with 80 micron thickness.
Diffuser	High permeable opal
Cooler	Cooling from the body surface
Colour	Grey
Box Dimensions	220x220x175 mm

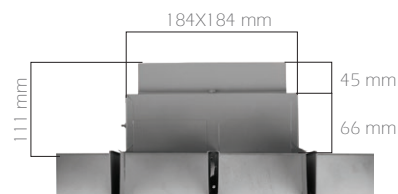

PGH/M

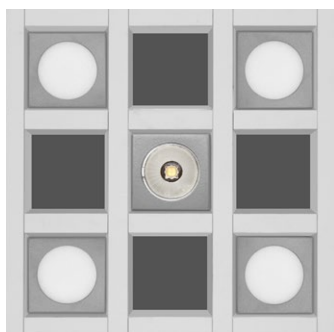

IP20

Code	PGH/MR	PGH/MOP
LED	High efficiency LED	
System Power	5W	5W
Colour Temperature	3000 - 4000 - 5000 K	
Voltage	220V - 50Hz	
Body	0.6mm DKP sheet. Painted with electro-static powder paint.	
Reflector	Aluminum	—
Diffuser	—	Opal
Colour	Grey	

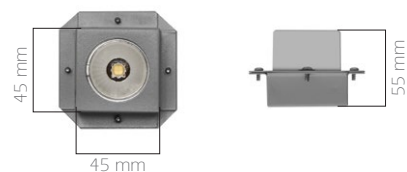



## Surface Mounted

## SCP/S

IP54



220V AC - DOB



These round-shaped products are surface mounted fixtures. Since light can be extremely homogenous and the protection class is high, the usage of areas are also quite large. Luminaires can be made at two different heights. Luminaires can be more functional by offering kit and sensor mounting option.

## SCP/N

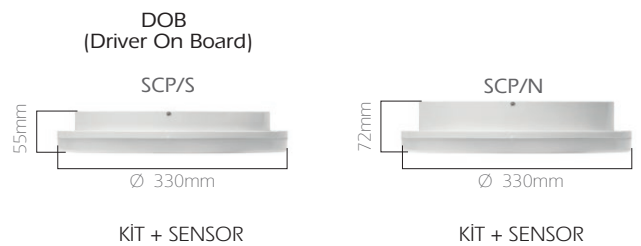

Code	SCP/S	SCP/N	SCP/S (DOB)
LED	High Efficiency Mid-Power LED		
Power	24W		20W
Light Flux	2.050 lm		1700 lm
Driver	Included		Driver on Board
Colour Temperature	3.000 - 4.000 - 5.000 K		
Voltage	180 -240 V / 50hz		
Body	Polycarbonate		
Diffuser	Polycarbonate - opal		
Emergency Kit	—	1 - 3 hrs	—

PNS

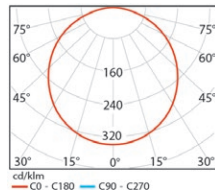

Code	PNS
LED	High Efficiency Mid-Power LED
System Power	13 W
Light Flux	1.000 lm
Colour Temperature	3000 - 4000 - 5000 K
Voltage	220V - 50Hz
Body	Spinning sheet
Frame	1,5mm thick DKP
Diffuser	1,2mm Opal
Colour	White, grey, black
Optional	1 hrs kit

IP20

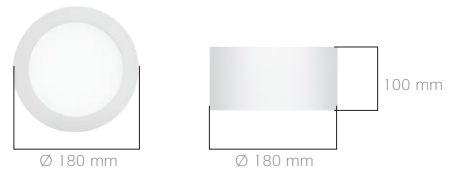

RLP/S

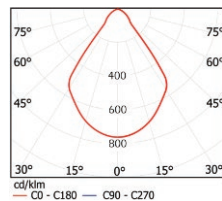
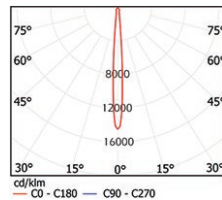

Code	RLP/S 13	RLP/S 27
LED	High Efficiency COB LED	
LED Power	13 W	27 W
Light Flux	1,350 lm	2.500 lm
Colour Temperature	3000 - 4000 - 5000 K	
Voltage	220V - 50Hz	
Body	Aluminum extrusion and aluminum frame	
Reflector	99% pure aluminum	
Diffuser	3 mm thickness transparent tempered glass	
Cooler	Aluminum extrusion	
Colour	White	

IP20

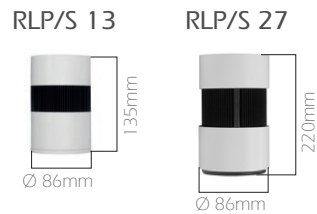

Optional Type

SLK



Code	SLK/18	SLY/15	SLY/18	SLY/M18 Light Sensor Type
LED	High Efficiency Mid-Power Led			
Power	18W	15W	18W	18W
Luminous Flux	1800lm	1380lm	1550lm	1550lm
Colour Temperature	3.000 K	4.000 K	4.000 K	4.000 K
Voltage	180 -240 V / 50hz			
Body	Polycarbonate body			
Diffuser	Polycarbonate opal			
Weight	900 gr	400 gr	615 gr	615 gr

IP44

SLY

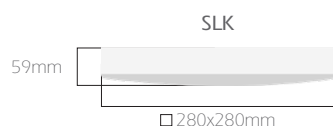

Code	a
SLY/15	220 mm
SLY/18	280 mm

Office Lighting

OFISLED

IP20

LGS has been developed to transfer high LED technology to office lighting. Production is possible for all types of suspended ceilings. Therefore, production is made according to the brand/model of the suspended ceiling to be used. Glare and screen reflections have been taken into consideration in the optical design of the fixture which are the most important requirements in offices and Cat-1 Cat-2 types of the fixture have been developed. OFISLED is a lighting system which meets its investments by the savings it provides by renewal of existing systems thanks to high effectiveness of the LEDs and fixture efficiency compared to conventional fluorescents and T5 fixtures.



LGS 60-60/3



LGS 60-60/4

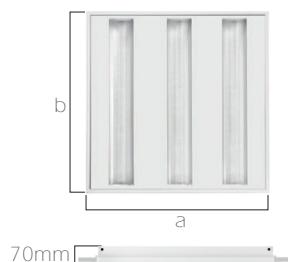

	Code	a	b	Cut-Out
GYPSUM	LGS 001 30-60	295mm	595mm	280x580mm
	LGS 001 60-60	595mm	595mm	580x580mm
	LGS 001 30-120	295mm	1195mm	280x1180mm
CLIP-IN	LGS 002 30-60	299mm	599mm	-
	LGS 002 60-60	599mm	599mm	-
	LGS 002 30-120	299mm	1199mm	-
MODULAR	LGS 300 30-60	295mm	595mm	-
	LGS 300 60-60	595mm	595mm	-
	LGS 300 30-120	295mm	1195mm	-

Code	LGS 60-60/3	LGS 60-60/4	LGS 30-120/2
LED	High Efficiency Mid-Power LED		
System Power	27 W	35 W	52 W
Light Flux	2,340 lm	3,000 lm	4.100 lm
Colour Temperature	3000 - 4000 - 5000 K		
Driver	Osram or Tridonic		
Voltage	220V - 50Hz		
Body	0,6 mm A1 quality DKP sheet steel 80 micron powder paint		
Optic	Cat-1,Cat-2	Cat-1,Cat-2	Cat-1,Cat-2
Reflector (inner)	Alanod Miro-Silver 27 AG aluminum		
Reflector (outer)	(Cat1) Alanod Miro Silver27/4270 AG aluminum (Cat2) Alanod Miro-Silver 20/2000 AG aluminum		
Diffuser	2,8 mm microprismatic lens		
Cooler	Cooling from the body surface		
Colour	White		
Box Dimensions	67x61x9cm	30x122x9cm	
Weight	5.000 gr	5.500 gr	

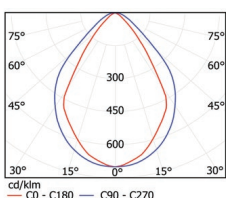



## Office Lighting

## OFISLED

IP20  
IP40 Optional

**LGO-MP (Micro-Prismatic diffuser)**  
Micro-prismatic diffuser creates variable effects according to your point of view

This is a fixture model with a wide usage and application. The light coming from multiple LED sources in LGO fixtures passes through the opal diffuser and provides an extremely soft and homogeneous distribution to the environment. Production for all types of suspended ceilings is possible. Therefore, production is made according to the brand/model of the suspended ceiling to be used. This fixture, like all Litpa fixtures is highly efficient and economical.

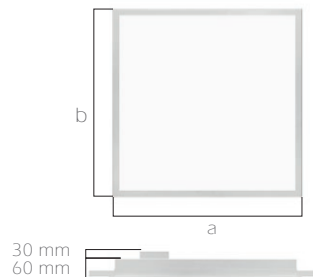

	Code	a	b	Cut-Out
GYPSUM	LGO 001 30-60	295mm	595mm	280x580mm
	LGO 001 60-60	595mm	595mm	580x580mm
	LGO 001 30-120	295mm	1195mm	280x1180mm
CLIP-IN	LGO 002 30-60	299mm	599mm	-
	LGO 002 60-60	599mm	599mm	-
	LGO 002 30-120	299mm	1199mm	-
MODULAR	LGO 300 30-60	295mm	595mm	-
	LGO 300 60-60	595mm	595mm	-
	LGO 300 30-120	295mm	1195mm	-
	LGO 300 60-120	595mm	1195mm	-

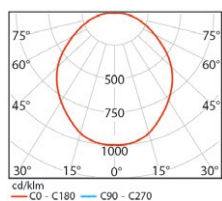

Code	LGO 60/29	LGO 60/36
LED	High Efficiency Mid-Power LED	
System Power	29 W	35 W
Light Flux	3,240 lm	3,940 lm
Colour Temperature	3000 - 4000 - 5000 K	
Voltage	220V - 50Hz	
Body	0,5mm thick DKP sheet steel. Frame made of 0,5mm thick DKP steel. 80 micron thick electrostatic powder paint	
Diffuser	1,2 mm Opal	
Cooler	Cooling from the body surface	
Colour	White	
Box Dimensions	65x64x14 cm	
Weight	4.500 gr	

Office Lighting

LEG-PR / LEG-OP

IP20

Glare and screen reflections have been taken into consideration in the optical design of the LEG series fixtures which are direct-indirect fixtures which are the most important requirements in offices. The fixture has been developed in direct - indirect mixed optical structure according to Cat-1 and Cat-2 types. The fixture is produced in different optical structures as double parabolic and opal. It is designed to be used in a suitable way in any office perfectly.



LEG-PR



LEG-OP

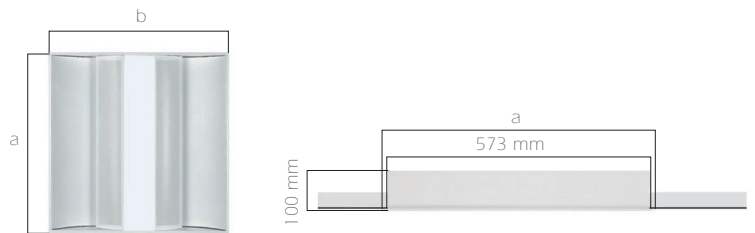

	Code	a	b	Cut-Out
<b>GYPSUM</b>	LEG-PR 001	595mm	595mm	580x580mm
	LEG-OP 001	595mm	595mm	580x580mm
<b>CLIP-IN</b>	LEG-PR 002	599mm	599mm	-
	LEG-OP 002	599mm	599mm	-
<b>MODULAR</b>	LEG-PR 300	595mm	595mm	-
	LEG-OP 300	595mm	595mm	-

Code	LEG-PR	LEG-OP
LED	High Efficiency Mid-Power LED	
System Power	26 - 35 W	26 - 37 W
Light Flux	1700 - 2280lm	1490 - 2120 lm
Colour Temperature	3000 - 4000 - 5000 K	
Voltage	220V - 50Hz	
Body	0,6mm thick DKP sheet steel	
Reflector	0,4 mm thick DKP sheet	
Cooler	Cooling from the body surface	
Colour	White	
Box Dimensions	61x67x12 cm	61x67x12 cm
Weight	4.900 gr	5.100 gr

LEG-PR

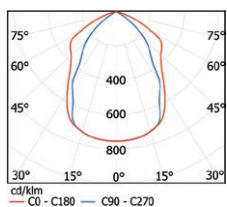

LEG-OP

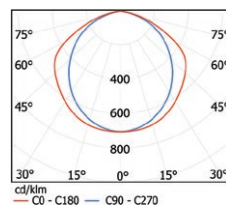

## Office Lighting

## MOON

IP20

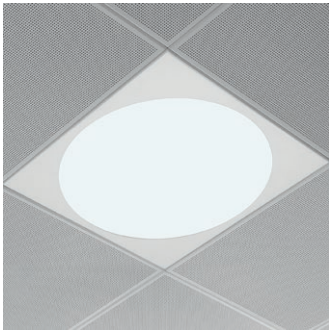

Desired patterns can be created upon request

OLG Series fixtures offer your esteemed side an option with rounded and stylish forms with high efficiency. They can be used single while they provide a distinctive ambiance to the spaces they are used when using side by side and in multi usage.

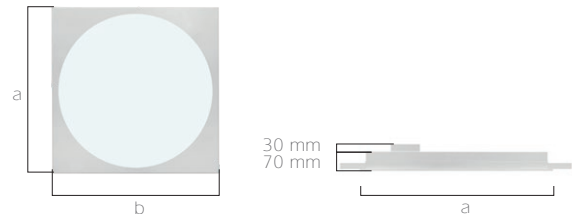

	Code	a	b	Cut-out
<b>GYPSUM</b>	OLG 60 001	595mm	595mm	580x580mm
<b>CLIP-IN</b>	OLG 60 002	599mm	599mm	-
<b>MODULAR</b>	OLG 60 300	595mm	595mm	-

Code	OLG 60/27	OLG 60/35
LED	High Efficiency Mid-Power LED	
System Power	27 W	35 W
Light Flux	2,300 lm	3,050 lm
Colour Temperature	3000 - 4000 - 5000 K	
Voltage	220V - 50Hz	
Body	0,5 mm thick A1 quality DKP sheet steel. 80 micron electrostatic powder paint.	
Cooler	Cooling from the body surface	
Diffuser	1,2mm thick opal	
Colour	White	
Box Dimensions	62x62x10 cm	
Weight	5.200 gr	

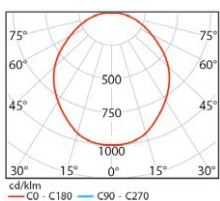



## Office Lighting

## FNSB-K

IP20



FNSB-K series designed in the form of square to be driven into the ceiling allows soft lighting applications and the LED technology used ensures energy-saving substantially. Ensures practical solutions thanks to its compliance with different types of suspended ceilings as well as different power ranges.

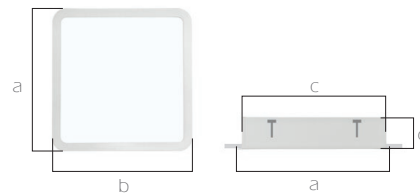

Code	a	b	c	d	Cut-Out
FNSB-K 20	200 mm	200 mm	169 mm	82 mm	175X175 mm
FNSB-K 40	400 mm	400 mm	369 mm	82 mm	375X375 mm

Code	FNSB-K 20	FNSB-K 40
LED	High Efficiency Mid-Power LED	
System Power	10W - 20W	20W - 30W
Light Flux	960 lm - 1,790 lm	1,990 lm - 2,680 lm
Colour Temperature	3000 - 4000 - 5000 K	
Voltage	220V - 50Hz	
Body	0.6 mm thick DKP sheet steel	
Diffuser	1,2mm opal	
Cooler	Cooling from the body surface	
Frame	1.5 mm thick DKP sheet steel	
Colour	White	
Box Dimensions	22x22x10 cm	42x42x10 cm
Weight	2.000 gr	3.000 gr

## Office Lighting

## FNSB-Y

IP20  
IP40 Optional

FNSB-Y series designed in the form of circle to be driven into the ceiling allows soft and diffuse lighting applications and the LED technology used ensures energy-saving substantially. Ensures practical solutions thanks to its compliance with different types of suspended ceilings as well as different power ranges.

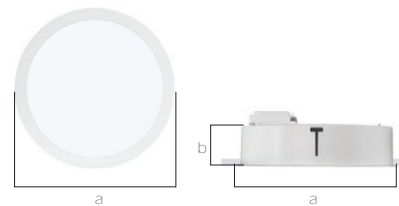

Code	a	b	Cut-Out
FNSB-Y 25	250 mm	82 mm	Ø 237 mm
FNSB-Y 35	350 mm	82 mm	Ø 327 mm
FNSB-Y 55	550 mm	82 mm	Ø 527 mm

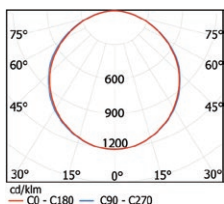

Code	FNSB-Y 25	FNSB-Y 35	FNSB-Y 55
LED	High Efficiency Mid-Power LED		
System Power	17 W - 24 W	22 W - 30 W	42 W
Light Flux	1,800 lm - 2,530 lm	1,650 lm - 3,160 lm	3,510 lm
Colour Temperature	3000 - 4000 - 5000 K		
Voltage	220V - 50Hz		
Body	0.8 mm thick DKP sheet steel		
Diffuser	1,2mm opal		
Cooler	Cooling from the body surface		
Frame	1.5 mm thick DKP sheet steel		
Colour	White		
Box Dimensions	27x27x10 cm	37x37x10 cm	57x57x10 cm
Weight	1.950 gr	3.100 gr	6.550 gr



Office Lighting

LSS

IP20

LSS luminaires, which are a surface mounted model of luminaire, are presented as a complete solution in the places such as offices and etc. in order to remove the problems of glare. It increases the productivity to the top level for the employees by increasing light quality in the work environment. They are produced with 2, 3 and four-lamelle according to the amount of the light requested. Thanks to high quality materials used, extremely high performance and savings are provided.



LSS 60-60/4



LSS 60-60/3



LSS 30-120/2  
Double parabolic reflector (optional)

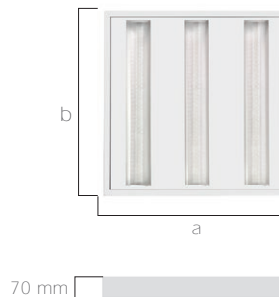

Code	a	b
LSS 60-60/4	600mm	600mm
LSS 60-60/3	600mm	600mm
LSS 30-30/2	300mm	300mm
LSS 30-120/2	300mm	1200mm

Code	LSS 60-60/4	LSS 60-60/3	LSS 30-30/2	LSS 30-120/2
LED	High Efficiency Mid-Power LED			
System Power	35 W	27 W	18 W	27 W
Light Flux	3,000 lm	2,344 lm	2,350 lm	2,200 lm
Colour Temperature	3000 - 4000 - 5000 K			
Driver	Osram or Tridonic			
Voltage	220V - 50Hz			
Body	0,6 mm A1 quality DKP sheet steel 80 micron powder paint			
Optic	Cat-1,Cat-2	Cat-1,Cat-2	Cat-1,Cat-2	Cat-1,Cat-2
Reflector (inner)	Alanod Miro-Silver 27 AG aluminum			
Reflector (outer)	(Cat1) Alanod Miro Silver27/4270 AG aluminum (Cat2) Alanod Miro-Silver 20/2000 AG aluminum			
Diffuser	2,8 mm microprismatic lens			
Cooler	Cooling from the body surface			
Colour	White			
Box Dimensions	67x61x9cm	67x61x9cm	37x31x9cm	127x31x9cm
Weight	5.700 gr	5.500 gr	2.800 gr	5.800 gr

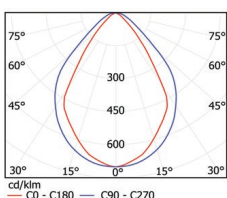

## Office Lighting

## LSO



LSO 60-60



LSO 30-120

IP20  
IP40 Optional

LSO luminaires, which have a lot of usage areas, are used in the places where there are no opportunities of recessed ceiling by installing onto the surface. They are produced with the shape square and rectangle according to the needs and meets different needs of power. They are produced with the understanding of eye-pleasing simple, stylish structure and high quality production.

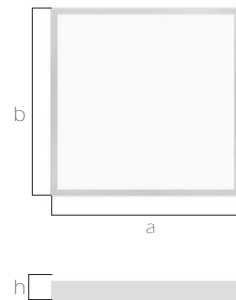

Code	a	b	h
LSO 30-30	370 mm	370 mm	80 mm
LSO 30-60	575 mm	300 mm	70 mm
LSO 60-60	605 mm	605 mm	70 mm
LSO 30-120	1150 mm	300 mm	70 mm

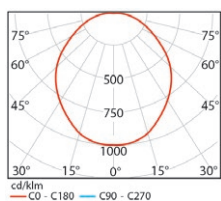

Code	LSO 30-30	LSO 30-120	LSO 60-60
LED	High Efficiency Mid-Power LED		
System Power	20 W	27-35-42W	27-35-42W
Light Flux	2.200 lm	2970-3850-4450lm	2970-3850-4450lm
Colour Temperature	3000 - 4000 - 5000 K		
Voltage	220V - 50Hz		
Body	0,60 DKP sheet		
Diffuser	1,2 mm thick opal		
Cooler	Cooling from the body surface		
Frame	1 mm DKP sheet		
Colour	White or Grey		
Box Dimensions	39x39x10 cm	32x122x8 cm	65x64x14 cm
Weight	2.000 gr	5.000 gr	5.100 gr

## Office Lighting

## LSL-P / LSL-OP

IP20

LSL Series fixtures are surface-mounted fixture with a wide high range of applications. The fixture is produced in different optical structures as double parabolic and opal. The high permeable lens material prevents the decrease of fixture efficiency while eliminating the problem of glare. It enables economic use by mounting to ceiling easily and thanks to the low energy consumption thereof.



LSL-P



LSL-OP

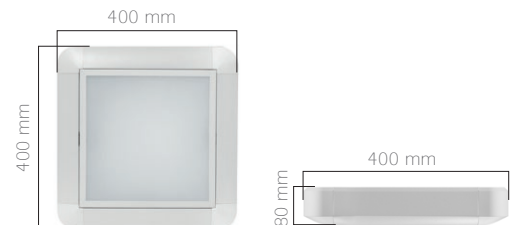

Code	LSL-P	LSL-OP
LED	High Efficiency Mid-Power LED	High Efficiency Mid-Power LED
System Power	18 W	14,5 W
Light Flux	2350 lm	1500 lm
Colour Temperature	3000 - 4000 - 5000 K	
Voltage	220V - 50Hz	
Body	0,6 mm thick DKP sheet steel	
Reflector	Alanod Miro Silver (only LSL/P)	
Diffuser	3mm Micro-Prismatic 92% transparent	1,2 mm opal
Cooler	Cooling from the body surface	
Colour	White	
Box Dimensions	42x42x9cm	
Weight	2.800 gr	2.500 gr



## Office Lighting

## FNSS-Y

IP20



FNSS-Y 60

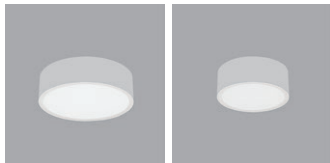

FNSS-Y 40

FNSS-Y 30

FNSS-Y model is a surface-mounted fixture in the form of circle with a stylish look and energy-saving is ensured substantially by virtue of the LED technology used and can be manufactured in various sizes.

FNSS-Y 60

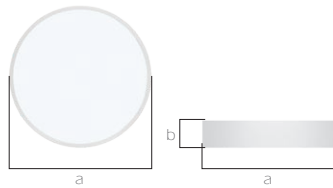

FNSS-Y 40

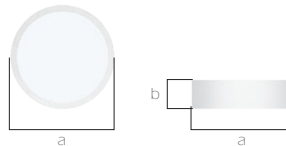

FNSS-Y 30

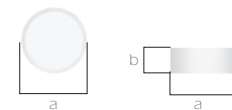

Code	a	b
FNSS-Y 30	260 mm	100 mm
FNSS-Y 40	350 mm	100 mm
FNSS-Y 60	550 mm	100 mm

Code	FNSS-Y 30	FNSS-Y 40	FNSS-Y 60
LED	High Efficiency Mid-Power LED		
System Power	17 - 24 W	20 / 30 W	40 W
Light Flux	1800/2530 lm	2320/3160 lm	3580 lm
Colour Temperature	3000 - 4000 - 5000 K		
Voltage	220 VAC - 50 Hz		
Body	1,5 mm thick DKP sheet		
Diffuser	1,2 mm thick opal		
Cooler	Cooling from the body surface		
Colour	White		
Box Dimensions	28x28x15 cm	36x36x12 cm	67x61x10 cm
Weight	1.950 gr	3.100 gr	6.550 gr



## Hygienic Room Luminaires

### HFC

IP54



Fixtures with high protection class are produced with specifications to be used in areas where cleaning is important.

Light coming from multi LED source in fixtures passes through a sandblasted specially produced glass, and provides an extremely soft and homogeneous distribution to the environment. Fixture efficiency is brought to the forefront in the clear glass option. It is possible to produce according to all types of suspended ceilings.

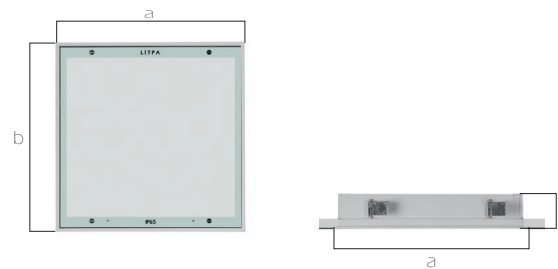

	Code	a	b	Cut-Out
<b>MODULAR</b>	HFC 300	595mm	595mm	580x580mm
<b>CLIP-IN</b>	HFC 002	599mm	599mm	-

Code	HFC
LED	High efficiency Mid-Power LED
System Power	40 W
Light Flux	3,750 lm
Colour Temperature	3000-4000-5000 K
Cooler	Cooling from the body surface
Voltage	220V - 50Hz
Body	0,6mm thick A1 quality DKP steel sheet. 80 micron electrostatic powder painted.
Glass	4mm thick tempered glass 1,2mm opal
Colour	White
Box Dimensions	62x62x13cm
Weight	9.000 gr

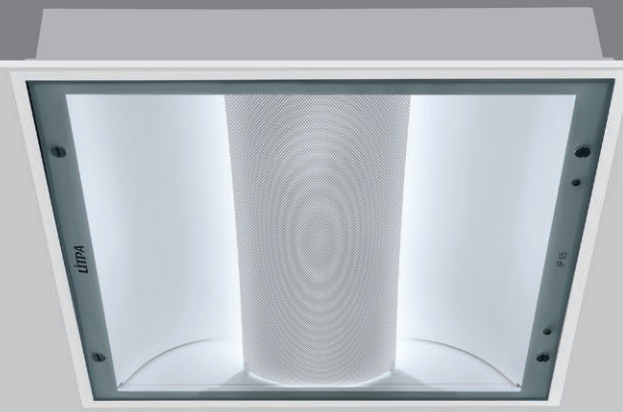

## Hygienic Room Luminaires

### HFC-SR

IP54



It is presented as a unique solution for hospitals, dentists and laboratories, where the provision of clean room conditions is obligatory in addition to its light distribution prevent glare. Liquid and dust particles that can penetrate into the fixture are prevented by fulfilling the requirements of high protection classes.



	Code	a	b	Cut-Out
<b>MODULAR</b>	HFC 300/SR	595mm	595mm	580x580mm
<b>CLIP-IN</b>	HFC 002/SR	599mm	599mm	-

Code	HFC-SR
LED	High efficiency Mid-Power LED
System Power	27W - 35W
Colour Temperature	3000-4000-5000 K
Cooler	Cooling from the body surface
Voltage	220V - 50Hz
Body	0,6mm thick A1 quality DKP sheet steel. Painted with 80 micron thick electrostatic paint.
Glass	Tempered and transparent glass
Reflector	0,4 mm thick DKP sheet with perforated lens
Colour	White
Box Dimensions	62x62x13cm
Weight	8.000 gr

# Linear Lighting

## EOSLED

IP20  
IP40 Optional

DFR fixtures which can be used as surface mounted and pendant are produced in 19 - 60 - 80mm width. They can be used as a single profile up to approximately 2.5 meters length in linear applications. They can be attached end to end and be used as a continuous light source. Height of the pendant can be easily adjusted thanks to spring mounting parts.

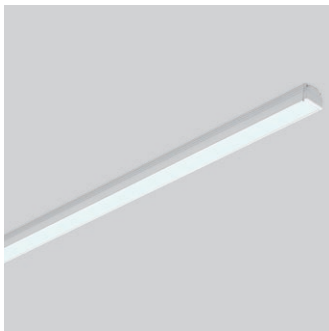

DFR 20

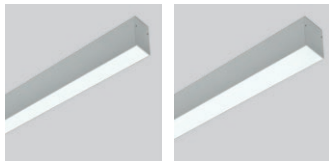

DFR 60

DFR 80

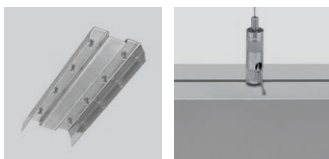

DFR BP

DFR AT

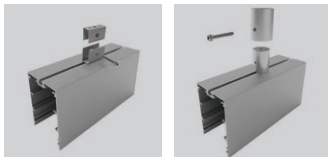

DFR SP1

DFR SP2

DFR 60 - 80

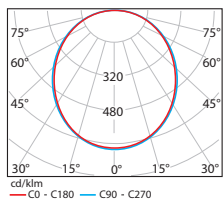

Code	a	b	c
DFR 20/100	1024mm	19mm	16mm
DFR 20/120	1194mm	19mm	16mm
DFR 20/150	1528mm	19mm	16mm
DFR 60/100	1024mm	60mm	85mm
DFR 60/120	1194mm	60mm	85mm
DFR 60/150	1528mm	60mm	85mm
DFR 80/100	1024mm	80mm	85mm
DFR 80/120	1194mm	80mm	85mm
DFR 80/150	1528mm	80mm	85mm

Code	DFR 20/100 DFR 20/120 DFR 20/150	DFR 60/100 DFR 60/120 DFR 60/150	DFR 80/100 DFR 80/120 DFR 80/150
LED	High efficiency Mid-Power LED		
System Power	15 W 18 W 27 W	30 W 36 W 45 W	30 W 36 W 45 W
Light Flux	1.400 lm 1.600 lm 2.100 lm	2.800 lm 3.300 lm 4.000 lm	2.800 lm 3.300 lm 4.000 lm
Colour Temperature	3000 - 4000 - 5000 K		
Voltage	220V - 50Hz		
Body	Aluminum extrusion body 80 micron electrostatic powder coated with paint.		
Diffuser	2,8 mm thick prismatic		
Colour	White or Grey		
Weight	500 gr 600 gr 750 gr	3000 gr 3750 gr 4500 gr	3400 gr 4100 gr 5200 gr

## Linear Lighting

### EOSLED

IP20  
IP40 Optional

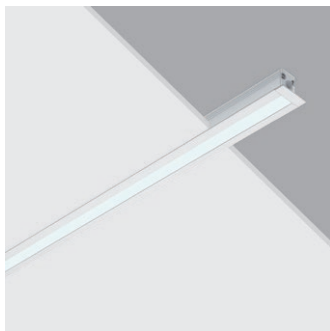

DFG 20

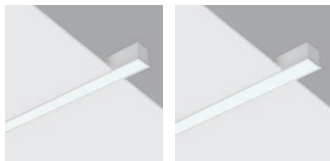

DFG 60

DFG 80



DFR BP

DFG fixture series, which are the recessed type of EOSLED are produced in different widths. They can be used as a single profile up to approximately 2.5 meters length in linear applications. They can be attached end to end and be used as a continuous light source. Puller ceiling mounting device has been used in order to adhere to the surface of the edge of the frame thoroughly on the ceiling. Light coming from the LED source creates an extremely soft ambiance by passing through the prismatic diffusers.



Code	a	b	c
DFG 20/100	1038mm	35mm	16mm
DFG 20/120	1208mm	35mm	16mm
DFG 20/150	1542mm	35mm	16mm
DFG 60/100	1034mm	75mm	85mm
DFG 60/120	1204mm	75mm	85mm
DFG 60/150	1538mm	75mm	85mm
DFG 80/100	1034mm	95mm	85mm
DFG 80/120	1204mm	95mm	85mm
DFG 80/150	1538mm	95mm	85mm

Code	DFG 20/100 DFG 20/120 DFG 20/150	DFG 60/100 DFG 60/120 DFG 60/150	DFG 80/100 DFG 80/120 DFG 80/150
LED	High efficiency Mid-Power LED		
System Power	15 W 18 W 27 W	30 W 36 W 45 W	30 W 36 W 45 W
Light Flux	1.400 lm 1.600 lm 2.100 lm	2.800 lm 3.300 lm 4.000 lm	2.800 lm 3.300 lm 4.000 lm
Colour Temperature	3000 - 4000 - 5000 K		
Voltage	220V - 50Hz		
Body	Aluminum extrusion body 80 micron electrostatic powder coated with paint.		
Diffuser	2,8 mm thick prismatic		
Colour	White or Grey		
Weight	500 gr 600 gr 750 gr	3000 gr 3750 gr 4500 gr	3400 gr 4100 gr 5200 gr

DFG 60 - 80

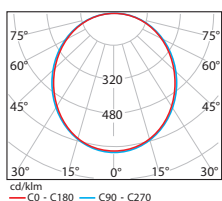

# Linear Lighting

## Karizma

IP20

KARIZMA luminaries, which can be used as surface-mounted or pendant, are produced with the widths of 60 - 80 mm. They can be used as a single profile with the length of up to about 1,5 m in linear applications. Thanks to special mounting apparatuses, pendant length can easily be adjusted.



DFR 80/C

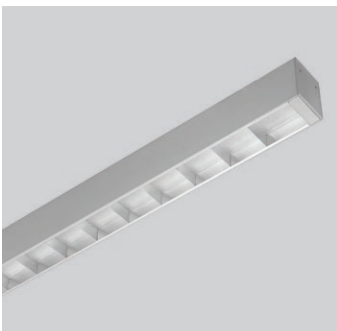

DFR 60/C



DFR BP



DFR SP

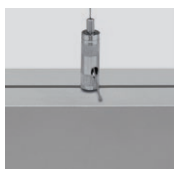

DFR AT



Code	a	b	c
DFR 60/C100	1040mm	60mm	85mm
DFR 60/C150	1540mm	60mm	85mm
DFR 80/C100	1040mm	80mm	85mm
DFR 80/C150	1540mm	80mm	85mm

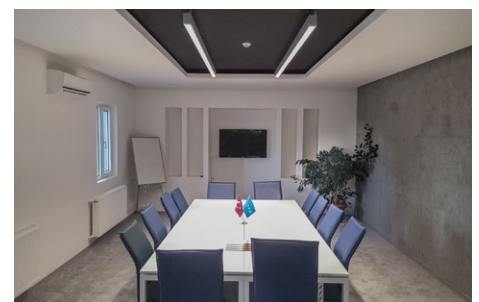

Code	DFR 60/C 100	DFR 60/C 150	DFR 80/C 100	DFR 80/C 150
LED	High efficiency Mid-Power LED			
System Power	36W	54W	36W	54W
Light Flux	3000lm	4460lm	3030lm	4550lm
Colour Temperature	3000 - 4000 - 5000 K			
Voltage	220V - 50Hz			
Body	Aluminum extrusion body and painted with electrostatic powder paint.			
Diffuser	2,8 mm thick prismatic lens			
Reflector	Double parabolic - high pure aluminum			
Colour	White or Grey			
Weight	3000gr	4500gr	3400gr	5200gr

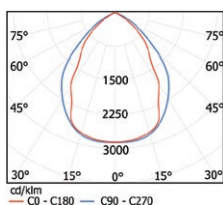

## Linear Lighting

### DFH Direct-Indirect

IP20

DFH fixtures which can be used as pendant and give direct and indirect light at the same time are produced in 60mm and 80mm widths. They can be manufactured in one piece up to approximately 2.5 meters length in linear applications. They can be attached end to end and be used as a continuous light source. Height of the pendant can be easily adjusted thanks to spring mounting parts.

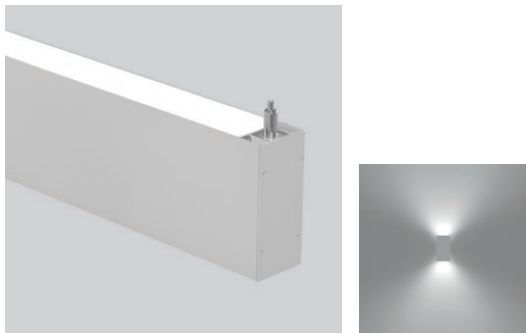

DFR AT



Code	a	b	c
DFH 60/100	1024mm	60mm	138mm
DFH 60/120	1194mm	60mm	138mm
DFH 60/150	1528mm	60mm	138mm
DFH 80/100	1024mm	80mm	183mm
DFH 80/120	1194mm	80mm	183mm
DFH 80/150	1528mm	80mm	183mm

Code	DFH 60/100 DFH 60/120 DFH 60/150	DFH 80/100 DFH 80/120 DFH 80/150
LED	High efficiency Mid-Power LED	
System Power	30 W 36 W 45 W	30 W 36 W 45 W
Light Flux	2,800 lm/m 3,360 lm/m 4,200 lm/m	2,800 lm/m 3,360 lm/m 4,200 lm/m
Colour Temperature	3000-4000-5000 K	
Voltage	220V - 50Hz	
Body	1.6 mm thick extrusion aluminum	
Diffuser	1.25 mm thick prismatic diffuser	
Reflector	0,4 mm thick 99,9% pure aluminum (optional)	
End-cap	Aluminum injection	
Colour	White or Grey	

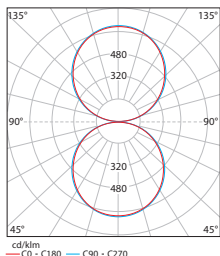



Linear Luminaires

DFR40

IP20

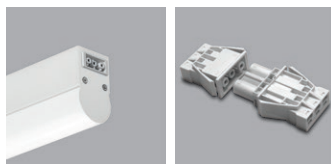

Connector for linear application

The DFR 40 is a type of luminaire suitable for various places with its slim, elegant appearance and ease of use. It is an economic model thanks to its simple design. The luminaire can be easily assembled. The connection cable does not disturb the luminaire image because it passes through the middle of the luminaire. Independent and linear applications are among the features of this luminaire.

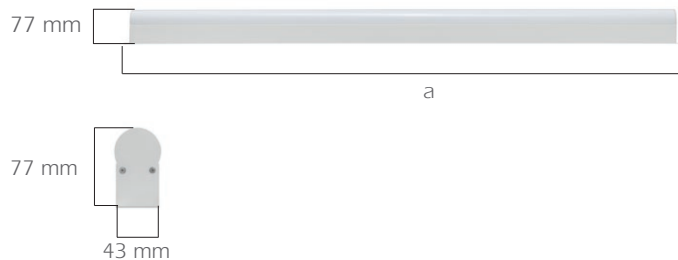

Code	a
DFR40/60	560 mm
DFR40/120	1.100 mm

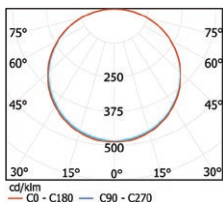

Code	DFR40/60	DFR40/120
LED	Midpower Led	
System Power	17 W	34 W
Light Flux	1350 lm	2640lm
Colour Temperature	3000-4000-5000 K	
Voltage	220V - 50Hz	
Body	Aluminum extrusion	
Diffuser	Opal - Acrylic diffuser	
Colour	White	



## Decorative Luminaires

## BLOOM

IP20



They can be used single while it is possible to create quite different shapes by using side by side and in multi usage. It can be used alone together as using multiple. What a designer can achieve is only limited to his own imagination with multiple usages of color options. They are designed for use in wall and ceiling surfaces. The aesthetic effect it creates on the surface even when the fixtures are deactivated reflects the unique design approach thereof.

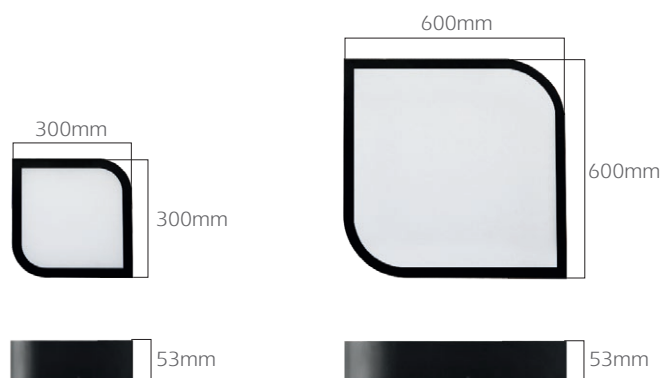

Code	BLM 30	BLM 60
LED	High efficiency Mid-Power LED	
System Power	15 W	27 W
Light Flux	1,600 lm	2,700 lm
Colour Temperature	2700-3000-4000-5000K, R-G-B	
Voltage	220V - 50Hz	
Body	Manufactured from DKP sheet steel	
Diffuser	Opal	
Cooler	Cooling from the body surface	
Colour	Optional - RAL colour	
Box Dimensions	31x31x6cm	61x61x6cm
Weight	2.800 gr	4.800 gr



## Decorative Luminaires

## SLO

IP20



SLO luminaires are very wide range of luminaires. The circular structure of the luminaire reveals a unique mood in the room. The snap-on mechanism, which can be adjusted in height, provides great convenience in installation. The array of LEDs integrates with the opal diffuser to provide extremely soft light distribution. In terms of being able to adapt to the environment, they are presented in black and white colors.



Code	a	b
SLO 60	600 mm	114 mm
SLO 90	900 mm	114 mm
SLO 120	1200 mm	114 mm

Code	SLO 60	SLO 90	SLO 120
LED	High efficient Mid-Power LED		
System Power	30 W	45 W	60 W
Colour Temperature	3000 - 4000 - 5000 - 6500 K		
Voltage	220V - 50Hz		
Body	Aluminum		
Diffuser	Opal lens		
Colour	Black - White		
Accessory	Pendant apparatus		
Box Dimensions	62x62x16cm	92x92x16cm	122x122x16

## Decorative Luminaires

## MOONY

IP20



Moony fixtures changing the uniformity of the circular structure surface mounted fixtures with a simple difference gives a stylish look to the surfaces. Fixture efficiency is at the highest level thanks to LED light source produced by high technology and high-permeable opal material.

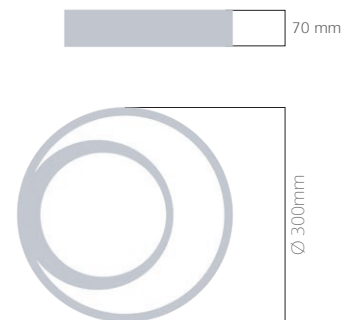

Code	MNG
LED	High efficiency Mid-Power LED
System Power	25 W
Light Flux	2,400 lm
Colour Temperature	3000 - 4000 - 5000 K
Voltage	220V - 50Hz
Body	Manufactured from 1mm DKP sheet steel.
Diffuser	Opal
Cooler	Cooling from the body surface
Colour	Optional
Box Dimensions	31x31x8 cm
Weight	3.300 gr

## Wall Luminaires

## DAP

IP40

Highly energy efficient DAP can be used in many areas of architecture thanks to its aesthetic wall mounting apparatus. It can be preferred as unidirectional and bidirectional according to the features of the area to be illuminated. LED lamps which can provide narrow and wide angle light can create the desired effect on the surface.

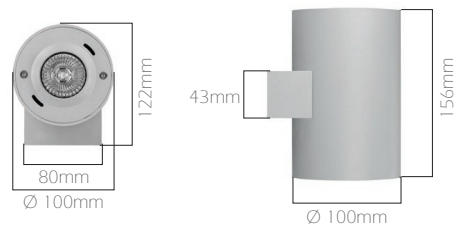
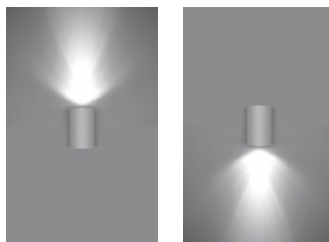

Code	DAP 15	DAP 25
LED	Par 16 Led lamp	
System Power	1x5 W	2x5 W
Colour Temperature	3000 - 4000 - 5000 K	
Voltage	220V - 50Hz	
Body	2.5 mm thick aluminum extrusion, epoxy polyester powder paint	
Colour	Grey	
Box Dimensions	21x22x16,5 cm	
Weight	1.450 gr	



## MDW

IP65

MDW brings distinction to the surrounding with its unusual design and advanced technology for both indoor and outdoor lighting applications. Besides combining light efficiency and comfort, this model offers another distinctive feature. It creates a mystic ambiance integrated with the architecture. With its up, down and up/down variations, architectural details on the surface are illuminated with soft light.

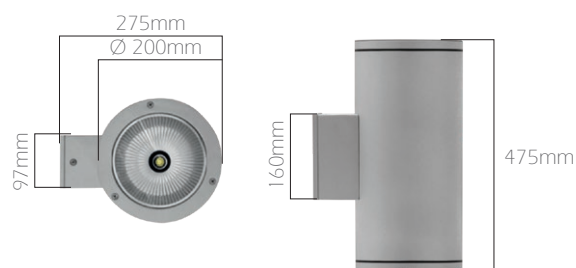
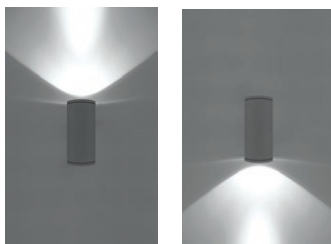

Code	MDW 113	MDW 213
LED	High efficiency COB LED	
System Power	1x13 W	2x13 W
Light Flux	1.170 lm	2.340 lm
Colour Temperature	3000 - 4000 - 5000 K	
Voltage	220V - 50Hz	
Body	3 mm thick aluminum extrusion	
Reflector	1 mm thick 99.9% pure aluminum	
Glass	5 mm tempered glass	
Colour	Grey	
Box Dimensions	30x44x22 cm	
Weight	7.000 gr	



## Wall Luminaires

## FSA

IP40



FSA series products which can be mounted vertically or horizontally on the wall thanks to the minimalist and cornered structure thereof create a dynamic atmosphere in the areas they are used. They are manufactured in a manner to give light in a double or single-sided (both up and down, or only below or above) way. Opal diffusers have been used in order that the fixtures can give light in a pleasant way by not making the eyes tired.



Code	a
FSA 118	610 mm
FSA 218	610 mm
FSA 136	1.210 mm
FSA 236	1.210 mm

Code	FSA118	FSA218	FSA136	FSA236
LED	High efficiency Mid-Power LED			
System Power	1x18W	2x18W	1x36W	2x36W
Light Flux	1680lm	2x1680lm	3360lm	2x3360lm
Colour Temperature	3000 - 4000 - 5000 K			
Voltage	220V - 50Hz			
Body	1 mm thick DKP sheet steel and 80 micron thick electrostatic powder paint			
Diffuser	5 mm thick opal			
Colour	Grey			
Box Dimensions	8x63x9 cm		8x123x9 cm	
Weight	3.000 gr		6.000 gr	

## Over Mirror Luminaires

## LML

IP44



The LML luminaires have a stylish and aesthetic sense with the ease of installation. Thanks to the opal diffuser, which has a high light output and a homogeneous light distribution, it prevents glare in over mirror use. The chrome-plated end caps provide adequate protection against ambient conditions. The luminaires are manufactured in a manner to be suitable for wall and ceiling use.



Code	LML60/10	LML60/16	LML60/20
LED	High efficiency Midpower LED		
Power	10W	16W	20W
Luminous Flux	1.000lm	1.600lm	2.050lm
Colour Temperature	3000-4000-5000K		
Voltage	220V - 50Hz		
Body	Aluminum extrusion - ABS material end caps are chrome coated		
Cooler	Aluminum		
Diffuser	Acrylic opal lens		

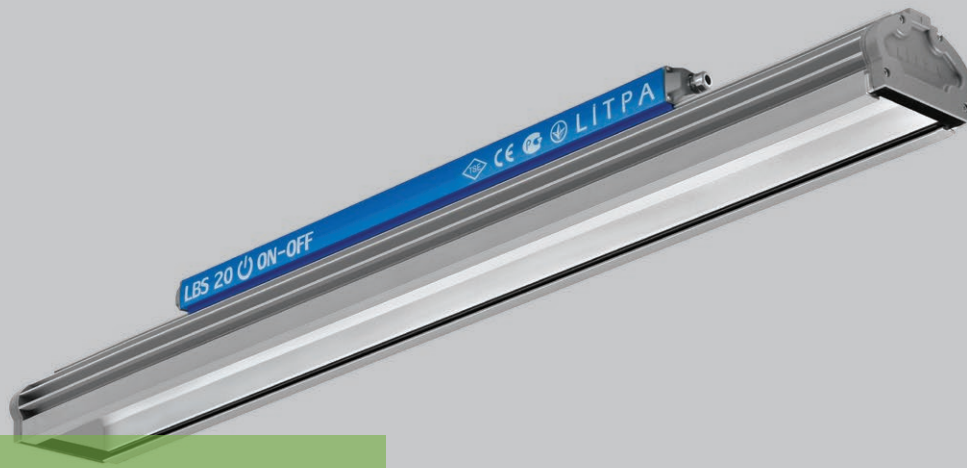

Industrial Lighting

ENDILED - High Efficiency

IP66

ENDILED luminaires are high protection class aluminum bodied fixtures produced with extremely high technology. They are suitable for use in many areas of industry, such as production areas, storage areas and particularly in high-ceilinged places. Reflectors produced with 98% optical efficiency by Alanod Miro-Silver technology are used in fixtures in order to ensure high efficiency. Heating problems are completely solved thanks to the aluminum body and PCB with high thermal conductivity aluminum.



Optional LBS/OP IP20

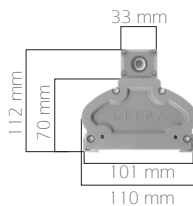

Code	a
LBS 6	686 mm
LBS 9	686 mm
LBS 12	1.286 mm
LBS 20	1.286 mm

Narrow Angle

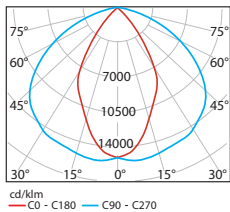

Medium Angle

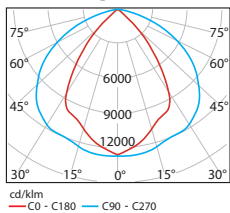

Wide Angle

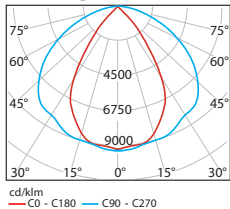

Code	LBS 6	LBS 9	LBS 12	LBS 20
LED	High efficiency Mid-Power LED			
System Power	46 W	68 W	78 W	140 W
Light Flux	6.800 lm	9.600 lm	11.600 lm	20.000 lm
Colour Temperature	3.000 - 4.000 - 5.000 - 6.500 K			
Driver	Osram			
Voltage	220 volt - 50hz			
Body	Aluminum extrusion body, end caps are aluminum injection			
Cooler	Aluminum special body structure ensuring quick heat transfer			
Reflector	Miro Silver 4: Bright narrow Miro Silver 5: Matt medium - wide			
Diffuser	Tempered glass or protective film Acrylic prismatic diffuser for soft applications. (IP20)			
Colour	Eloxal matt			
Box Dimensions	72x11x12cm		132x11x12cm	



Industrial Lighting

**100.000hrs**  
**Lifetime**

## ENDILED - Longlife

IP66



LBS Longlife Luminaires are industrial type luminaires that can be used in areas where replacement is difficult. They are luminaires that can be used without needing to change for a long time.

The special type, long life and high efficiency driver / LED are used in these Luminaires and therefore the life time of the luminaires is maximized.

The body of the luminaire is made of aluminum extrusion material and end caps are manufactured by aluminum injection.

The optical elements used in the luminaires have been developed to offer 3 different options depending on the height of the ceiling: narrow, medium and wide angle.

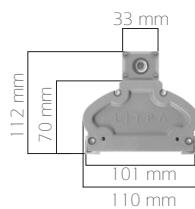

### Narrow Angle

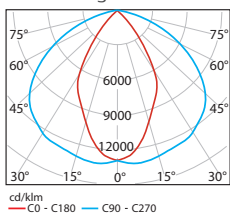

### Medium Angle

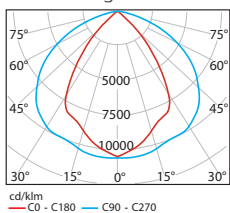

### Wide Angle

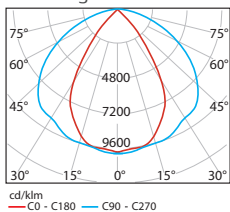

Code	LBS LL
LED	High efficiency Mid-Power LED
System Power	148 W
Light Flux	14.700 lm
Colour Temperature	3.000 - 4.000 - 5.000 - 6.500 K
Driver	Tridonic Pro - 200.000Lrs lifetime
Voltage	220 volt - 50hz
Body	Aluminum extrusion body, end caps are aluminum injection
Cooler	Aluminum special body structure ensuring quick heat transfer
Reflector	Miro Silver 4: Bright narrow - medium - wide Miro Silver 5: Matt narrow - medium - wide
Diffuser	Tempered glass or protective film
Colour	Eloxal matt
Box Dimensions	132x11x12cm



Industrial Lighting

TEKNOMAX

IP66

TEKNOMAX luminaires are designed for operating without any problems in industrial locations where luminaire bodies are exposed to harsh environment conditions. The luminous efficiency of the luminaires has been reached to extremely high levels. The luminaire efficiency comes from combining the optic design with the newest generation LEDs in the most appropriate way. Narrow and wide angle types of luminaires can be produced according to ceiling heights. Luminaires can be installed in any way using busbar, cable tanks and free hangers.

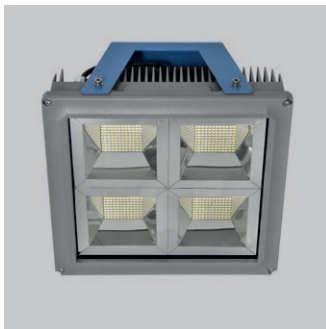

Brackets



HCL-YT/AB Busbar



HCL-YT/AK Cable Tray



HCL-YT/AG Free bracket



HCL-YT/AS

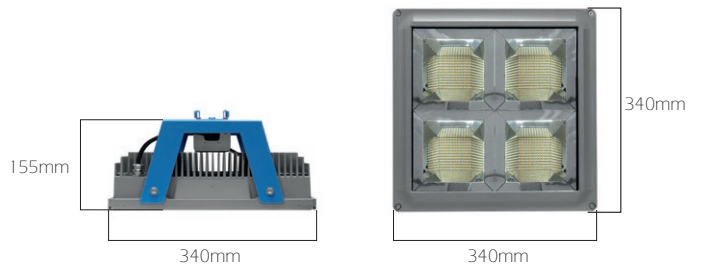

Narrow Angle

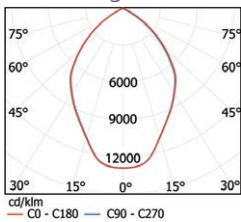

Wide Angle

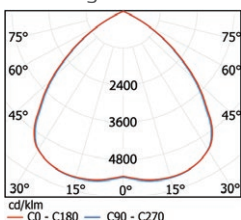

	Narrow Angle		Wide Angle
Code	HCL-YT 56/D HCL-YT 62/D HCL-YT 76/D HCL-YT 79/D	HCL-YT 83/D HCL-YT 88/D HCL-YT 98/D HCL-YT132/D	HCL-YT 83/G HCL-YT 88/G HCL-YT132/G
LED	High efficiency Mid-Power LED		
System Power	56W 62W 76W 79W	83W 88W 98W 132W	83W 88W 132W
Light Flux	9.289lm 10.362lm 12.693lm 12.974lm	13.376lm 14.030lm 15.632lm 20.643lm	13.556lm 14.085lm 20.770lm
Colour Temperature	3000 - 4000 - 5000 K		
Voltage	220V - 50Hz		
Body	Aluminum injection		
Reflector	Alanod Miro Silver aluminum		
Diffuser	Impact resistance tempered glass with serigraphy printed		
Colour	Grey		
Weight	13.000 gr		

## Industrial Lighting

## TERMOMAX

IP66



**+90°C**  
Ambient  
Temperature

Heavy industrial processes are carried out in industrial plants and industrial lighting must be designed and applied to these facilities to withstand harsh environmental conditions such as high temperature and humidity. TERMOMAX luminaires are designed with high efficiency and the ability to work without any problem at +90°C temperature in industrial plants.

The possibility of offering high performance solutions from the point of view of energy saving and offering a long-lasting system has made TERMOMAX one of the most competitive and future-proof technology in the industrial lighting sector. TERMOMAX luminaires produced with LEDs with long life and high efficiency have high light distribution levels with low energy levels.

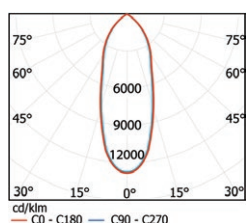
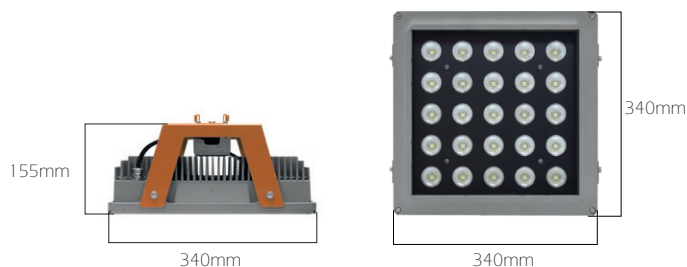

Code	HCL-TM
LED	High Power - Cree XHP70
System Power	70 W
Light Flux	8.560 lm
Operating Temperature	- 40° C ~ +90° C
Colour Temperature	3000 - 4000 - 5000 K
Voltage	220V - 50Hz
Body	Aluminum injection
Diffuser	Impact resistance tempered glass with serigraphy printed
Reflector	Ledil Minnie Reflector
Colour	Grey
Weight	12.000 gr



Weatherproof

## ELP

IP65



Code	a
ELP60	630 mm
ELP120	1230 mm

Code	ELP60-18	ELP120-35	ELP120-58
LED	High efficiency Mid-Power LED		
System Power	18W	35W	58W
Light Flux	1.850lm	4.280lm	5.100lm
Colour Temperature	3.000 - 4.000 - 5.000 K		
Voltage	220 volt - 50hz		
Body	Plastic extrusion polycarbonate, end caps are ABS		
Cooler	Aluminum extrusion		
Diffuser	Polycarbonate		
Colour	White - Gray		
Accessories	Stainless mounting clips		
Weight	1.160gr (ELP120)		

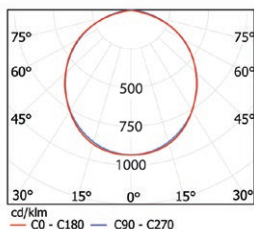

Weatherproof

## ELW

## IP65



Suspension System

ELW waterproof fixtures have high protection class aluminum extrusion body against water and dust with LED light source. They can be used in many areas such as parking lots, storage areas and other areas for industrial purposes. They provide extra energy savings by reducing the light when it is not needed thanks to their suitability for automation.

(Driver On Board)



IP65 Driver Type

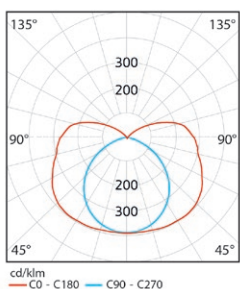
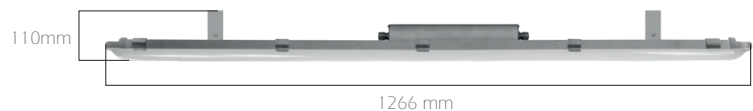

Code	ELW120-40	ELW120-60	ELW120-80
LED	High efficiency Mid-Power LED		
System Power	40 W	60 W	80 W
Light Flux	4.400lm	6.600lm	8.800lm
Colour Temperature	3000 - 4000 - 5000 - 6500 K		
Cooler	Cooling from the body surface		
Voltage	220 volt - 50hz		
Body	Aluminum extrusion		
Diffuser	Opal - Polycarbonate diffuser		
Colour	Matt anodized		
Accessory	Assembly springs		
Box Dimensions	17x132x12 cm		
Weight	3.100 gr		



Weatherproof

## ELP/M

IP65



The luminaires with ELP/M codes are produced with aluminum extruded housing, sealed end caps and IP67 connectors, providing high protection for damp and dusty environments. The high-permeability opal allows homogeneously spreading the light to the desired area. The luminaire product can be easily assembled and offers a light structure thanks to its aluminum body.

It creates an aesthetic stance with its elegant and curved structure in usage areas like warehouse, parking areas, production areas, workshops, technical areas, access roads.



Opal Diffuser



Aluminum Body



Driver inside

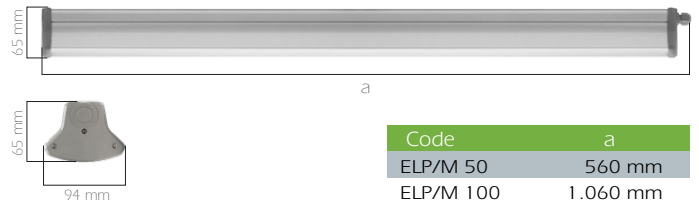

Code	a
ELP/M 50	560 mm
ELP/M 100	1.060 mm
ELP/M 150	1.560 mm

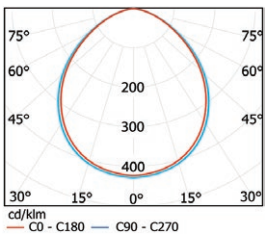

Code	ELP/M 50		ELP/M 100		ELP/M 150		
LED	High efficiency Mid-Power LED						
System Power	10W	20W	20W	29W	20W	29W	40W
Light Flux	1.200lm	2.400lm	2.400lm	3.600lm	2.400lm	3.600lm	5.000lm
Colour Temperature	4.000 - 5.000 - 6.500 K						
Voltage	220 volt - 50hz						
Body	Aluminum extrusion						
Cooler	Cooling from the body surface						
Diffuser	Polycarbonate opal						
Colour	Eloxal body, end caps are grey						
Accessories	Assembly accessories are stainless steel IP67 connector						
Weight	1.850gr (ELP/M 100)						



## Emergency Lighting

### LXT

### IP40



Litpa emergency exit and steering luminaire is a reliable luminaire option with high quality material structure and technical specifications. Suitable for single face and double face use. Suitable for many areas of use, from offices to meeting rooms, shopping centers to schools.

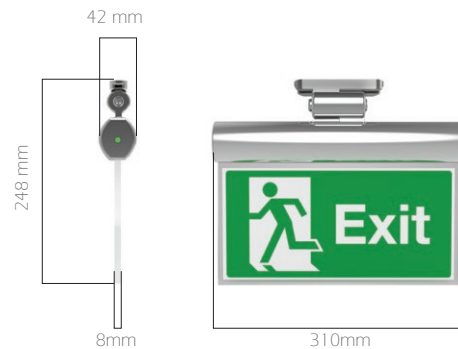

Code	LXT
Environment	Wall and Ceiling Surface
LED	Midpower LED
Power	3W
Light Flux	95lm
Charging Time	24 hrs
Decharging Time	3 hrs
Working Temperature	-5°C + 45°C
Class	I
Battery	1.2Vdc 1000mAh durable Ni-Cd
Diffuser	Plexiglass
Colour Temperature	6000 K
Voltage	220 volt - 50hz
Görülebilirlik	15 - 30m

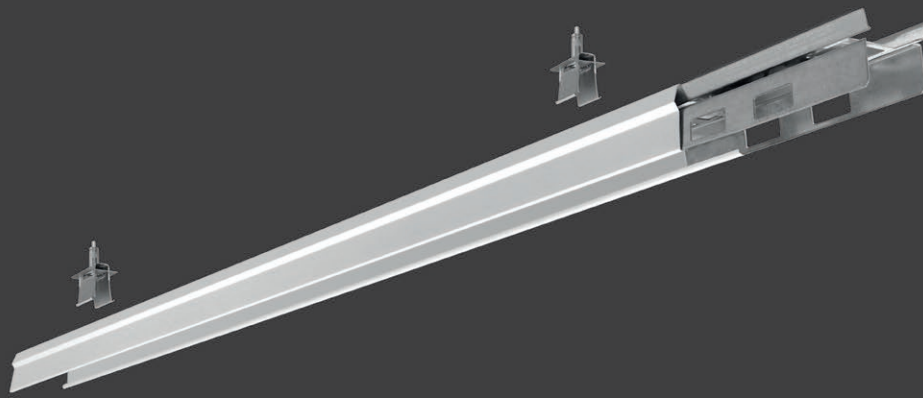

## Linear Lighting

### TRL



The TRL trunking system can be inserted end-to-end in a linear manner. Trunking lengths can be made in different lengths from 1.5 meters to 4.5 meters. The joining members firmly secure the channel modules together. Various mounting parts that can be used in different pans or hanger systems allow easy installation without any problems.

**Body:**

It is produced by aluminum extrusion method. At least 80 micron thick electrostatic powder painted. U-shaped design and strength-enhancing folds keep the stretch of the linear trunking at a minimum and prevent sagging aesthetics.

**Properties:**

The contractors on the cable gates inside the trunking allow phase selection using the adjustable terminals from the top cover of the LED modules. 5-wire and 7-wire systems are available. In the 5-wire system, it carries 3 phases, neutral and ground lines within the trunking. The user can choose between 3 phases. In 7-wire system, it carries 3-phase, neutral and earth lines and also carries 2 cables. These cables are used as DALI automation line. Here again, phase selection is made and the data is transferred to the fixture module from 2 points.

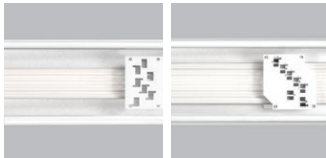

TRL5

TRL7



Code	Length	LxWxH
TRL5/150	Single Length (1x)	1.500x68x55 mm
TRL5/300	Double Length (2x)	3.000x68x55 mm
TRL5/450	Triple Length (3x)	4.500x68x55 mm
TRL7/150	Single Length (1x)	1.500x68x55 mm
TRL7/300	Double Length (2x)	3.000x68x55 mm
TRL7/450	Triple Length (3x)	4.500x68x55 mm

CHA



Chain hanger

TWA



Suspension bracket

FRA



Free suspension

TCN



Canal connection apparatus

CAP



End Cap

CTR



Cable canal





## Linear Lighting

### TCR

IP20



TCR is a highly efficient fixture series developed to apply LED technology in lighting of supermarkets, hobby stores, electronics stores as well as production areas that do not require high protection class such as warehouses, hangars and other interior spaces. The light coming from the LED light source is directed to usage areas with high efficiency in fixtures. It creates an extremely comfortable, refreshing and not disturbing environment due to both the quality of light and to low dazzling feature of the light directed from the prismatic diffusers.

### Trunking System



Luminaires can be produced according to the trunking system.

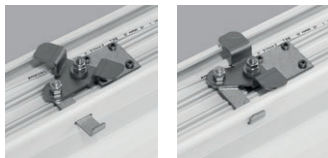

TRL canal can be easily installed by pressing the lock on the luminaire body with the finger.

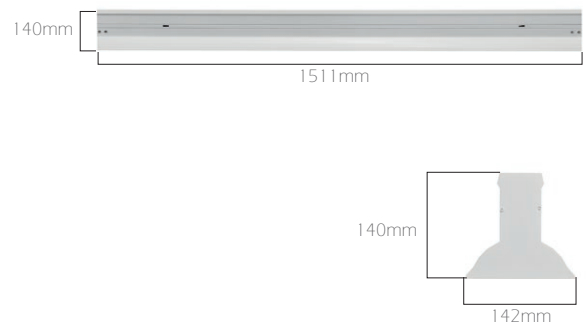

Code	TCR 35	TCR 50
LED	High efficiency Mid-Power LED	
System Power	35W	50W
Light Flux	3.300 lm	4.750 lm
Colour Temperature	3000 - 4000 - 5000 K	
Driver	Osram, Tridonic or Helvar	
Voltage	220V - 50Hz	
Body - Reflector	0,6 mm thick DKP sheet steel	
Diffuser	Prismatic lens	
Cooler	Cooling from the body surface	
Colour	White	
Accessory	Pendant, connection apparatus, end-cap	
Box Dimensions	12x15x152cm	
Weight	4.000 gr	

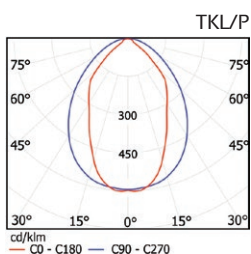

## Linear Lighting

### TCA

IP20



Teknoline TCA coded products provide high luminous efficiency in many areas. Both lens and LED quality and efficiency are the highest in the products. The fixture body integrates with the aluminum extrusion material and provides adequate and uniform cooling.

There is a separate optical chamber for each LED. In this way, the light coming out of the leds is controlled with every direction, while the glare is minimized.

### Trunking System

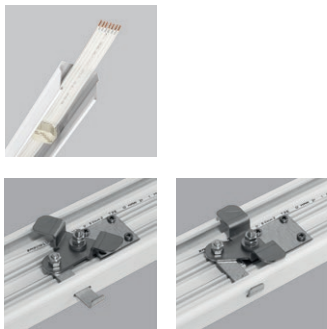

TRL canal can be easily installed by pressing the lock on the luminaire body with the finger.

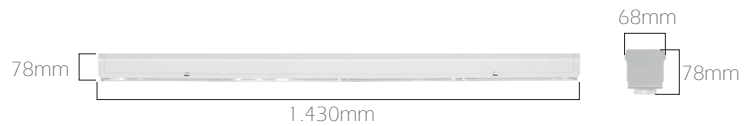

Code	TCA150HE	TCA150HO		
LED	High efficiency Mid-Power LED			
System Power	43W	65W		
Light Flux	5.010lm 4.990lm 4.840lm 4.970lm	Medium Beam Wide Beam Asymmetrical Double Asym.	6.730lm 6.710lm 6.540lm 6.680lm	Medium Beam Wide Beam Asymmetrical Double Asym.
Colour Temperature	3000 - 4000 - 5000 - 6.500K			
Voltage	220V - 50Hz			
Body	Aluminum extrusion			
Diffuser	Vossloh Schwabe or Ledil lens			
Cooler	Cooling from the body surface			
Colour	White			
Box Dimension	162x18x13cm)			
Weight	6.4kg (4pcs in box)			



## Linear Lighting

### TCE

IP20



Teknoline TCE products provide high luminous efficiency in many areas. Both lens and LED quality and efficiency are the highest in the products. The fixture body integrates with the aluminum extrusion material and provides adequate and uniform cooling.

There is a separate optical chamber for each LED. In this way, the light coming out of the leds is controlled with every direction, while the glare is minimized.

### Trunking System

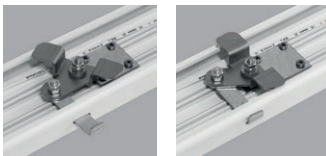
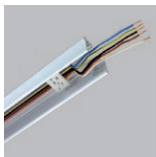

TRL canal can be easily installed by pressing the lock on the luminaire body with the finger.

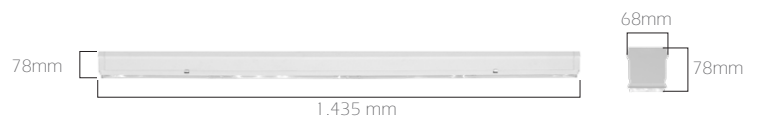

Code	TCE150HE	TCE150HO
LED	High efficiency Mid-Power LED	
System Power	44W	62W
Light Flux	5.990lm Narrow Beam 6.030lm Wide Beam 5.910lm Very Wide Beam 5.900lm Asymmetrical 6.040lm Double Asym.	7.810lm Narrow Beam 7.830lm Wide Beam 7.650lm Very Wide Beam 7.670lm Asymmetrical 7.820lm Double Asym.
Colour Temperature	3000 - 4000 - 5000 - 6.500K	
Voltage	220V - 50Hz	
Body	Aluminum extrusion	
Diffuser	Vossloh Schwabe or Ledil lens	
Cooler	Cooling from the body surface	
Colour	White	
Box Dimension	162x18x13cm)	
Weight	7.5kg (4pcs in box)	

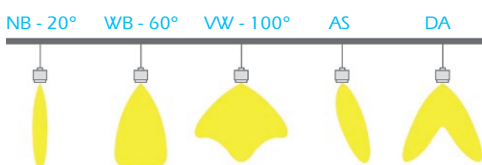



# INDEX

## **B**

BCL.....	6
BKL.....	7
BLM.....	57
BOLLARD.....	18
BLOOM.....	57
BTL.....	7

## **C**

CAIRO.....	6
CRA1.....	6
CRA2.....	6

## **D**

DAP.....	60
DFG.....	53
DFH.....	55
DFR.....	52
DFR40.....	56
D-LFA.....	16
D-LFB.....	16
D-LFK.....	16
D-LSD.....	19
D-LWD.....	19
D-LYD.....	19
DML.....	26
DOT.....	33
DR.....	32

## **E**

ELD.....	34
ELP.....	68
ELP/M.....	68
ELW.....	69
ENDILED.....	64
EOSLED.....	52

## **F**

FASHIONLED.....	26
FNSB-K.....	44
FNSB-Y.....	45
FNSS-Y.....	49
FSA.....	62

## **G**

GALAXYLED.....	29
----------------	----

## **H**

HADES.....	14
HERCULED.....	8-9
HCL.....	8-9
HCL-T.....	21
HCL-TM.....	67
HCL-YT.....	66
HFC.....	50
HFC-SR.....	51
HRN.....	35
HYL.....	14

## **K**

KARIZMA.....	54
--------------	----

## **L**

LBS.....	64
LBS LL.....	65
TCA.....	74
TCE.....	75
LDD.....	22
LEG-OP.....	42
LEG-PR.....	42
LGO.....	41
LGS.....	40
LKG.....	36
LKG/M.....	35
LML.....	63
LSL-OP.....	48
LSL-P.....	48
LSO.....	47
LSS.....	46
LSW.....	11
LYS.....	4
L1671.....	35
LXT.....	71

## **M**

MDW.....	61
ML110.....	34
MNG.....	59
MOON.....	43
MOONY.....	59
MSH.....	17

## **O**

OFISLED.....	40
OLG.....	43

## **P**

PETROLED.....	20
PGH.....	35
PNS.....	37
PTL.....	20
PUNTO.....	23

## **Q**

QTM.....	12-13
----------	-------

## **R**

RINGA.....	5
RLP.....	26
RLP/S.....	39
RLK.....	26
RLK/M.....	27
RNY.....	5
RTL.....	10

## **S**

SCP.....	38
SFR.....	30
SHOPLED.....	26
SHOWLED.....	28
SKYLINE.....	11
SLG.....	29
SLK.....	39
SLO.....	58
SLY.....	39
SMG/L.....	31
SSL.....	25
STRETRAY.....	4

## **T**

TEKNOLINE.....	73
TEKNOMAX.....	66
TERMOMAX.....	67
TCR.....	73
TRL.....	72

## **Y**

YLW.....	15
3007.....	18
8040.....	18
8050.....	18