



MAGNET ARMATÜR TAVAN MONTAJ TALIMATI
/ LUMIFLEX MAGNETIC TRAK SYSTEM ASSEMBLY INSTRUCTIONS



Aydınlatmada dünya markası olma yolunda bir Türk markası olan LİTA Aydınlatma'yı tercih ettiğiniz için teşekkür ederiz.
Thank You for choosing LİTA Lighting

Ölçüler milimetredir.
Dimensions in millimeters.

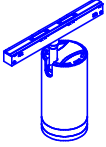

SPOTLIGHT

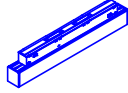

LINEAR

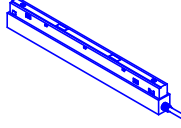

DRIVER



RAIL
CLAMPING
PIECE

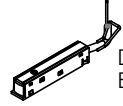

DALI ENERJİ
BAĞLANTISI



FLEXIBLE

CONNECTION

Notlar

1. Eğer ,bu armatürün, harici esnek kablosu hasar görürse, üretici firma, onun yetkili servisi ya da gerekli yetkinliğe sahip kişiler tarafından yenisi ile değiştirilecektir.
2. Armatür içindeki ışık kaynağı yalnızca, üretici firma, yetkili servis ya da gerekli yetkinliğe sahip kişi tarafından değiştirilebilir.

Notes

1. If the external flexible cable or cord of luminaire is damaged, it shall be replaced by a special cord exclusively available from the manufacturer, their service agent or similar qualified person.
2. The light source contained in this luminaire shall only be replaced by the manufacturer or his service agent or a similar qualified person.

LİTA AYDINLATMA SAN. VE TİC. A.Ş. / LİTA LIGHTING CO.

**MERKEZ (HEAD OFFICE) & FABRİKA (FACTORY) : Haraççı Hadımköy yolu Cad. No:15 Haraççı Mah.
Arnavutköy / İSTANBUL - TURKEY TEL : 90 (0) 212 683 09 87 (5 Hat) FAX : 90 (0) 212 683 09 92**

www.litpa.com

MONTAJ DETAYLARI / ASSAMBLING DETAILS

1. Sarkıt magnet ray montajı yapılırken telin ucundaki tavana montaj aparatı sökülüp tavana vida ile monte edilir, telin ucundaki başlık elle sıkılarak takılır.

2.Tavana monte edilen tel, profilin üzerindeki sarkıt tel asansöründen yükseklik ayarı yapılarak sabitlenir.

3.Ürün montajında 3 numaralı parçanın mutlaka takılı olması gerekmektedir.

1. When installing the pendant magnet rail, the ceiling mounting bracket at the end of the wire is removed and the wire is mounted to the ceiling with a screw. The cap at the end of the wire is tightened by hand.

2. The ceiling-mounted wire is secured by adjusting the height using the pendant wire lift on the profile.

3. Part number 3 must be installed during product installation.

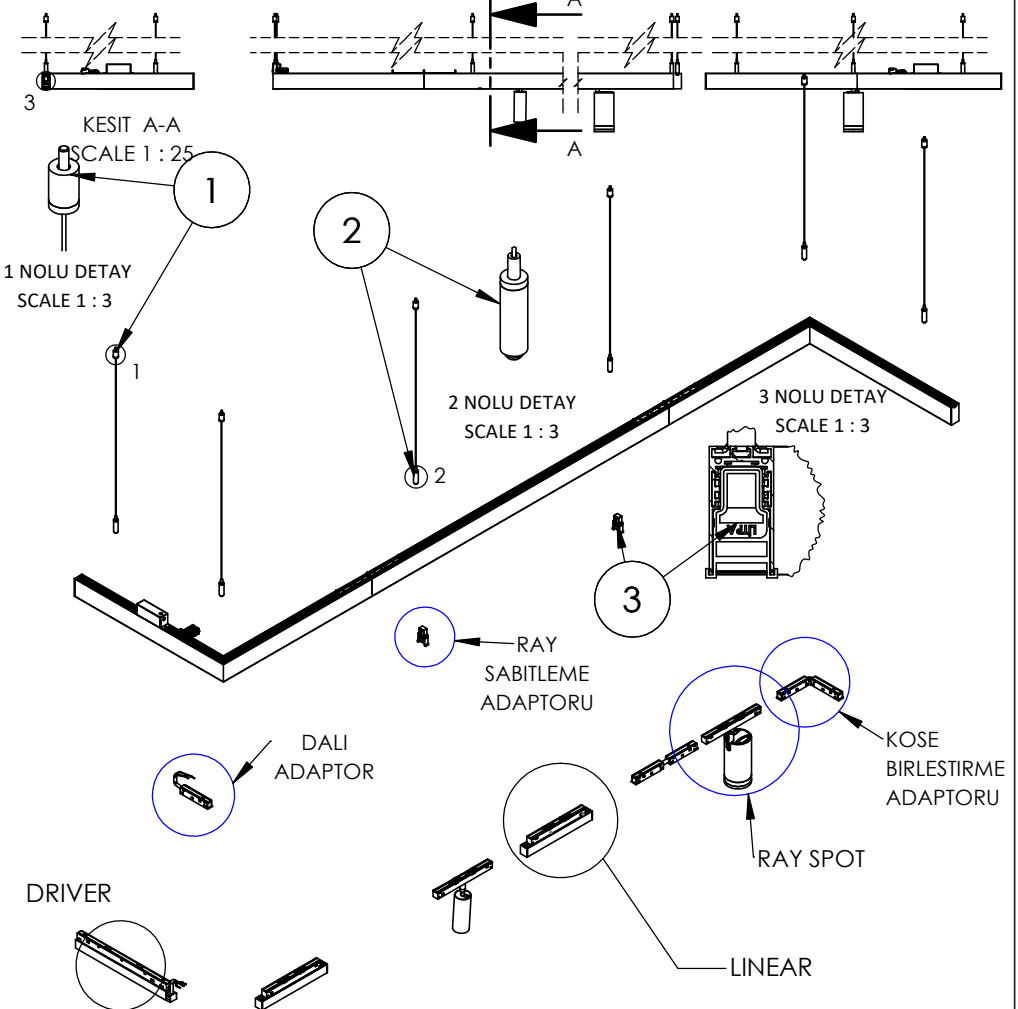

MONTAJ DETAYLARI / ASSAMBLING DETAILS

4 4,5 ve 6 nolu enerji detayları aşağıdaki şemalara göre yapılacaktır.

Energy details 4, 5, and 6 will be prepared according to the diagrams below.

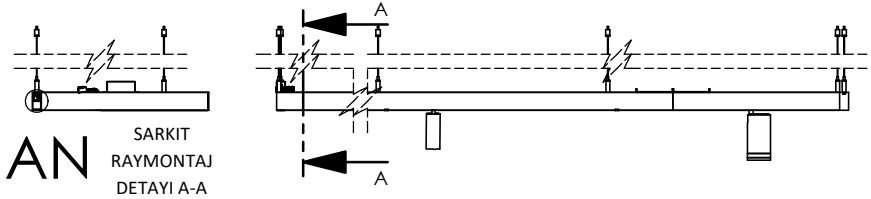

MONTAJ DETAYI :4/
ASSAMBLING DETAIL-4
DALI ENERJİ BAĞLANTI DETAYI

SCALE 1 : 5

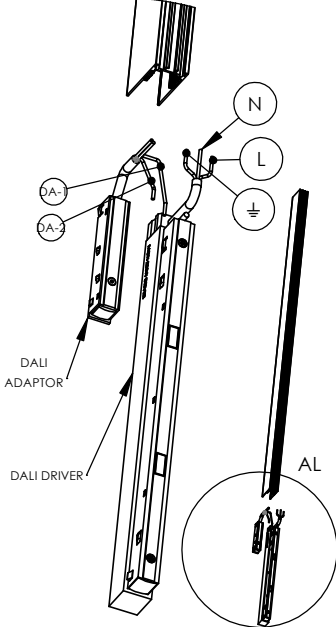

MONTAJ DETAYI :5/
ASSAMBLING DETAIL-5
RAY ENERJİ BAĞLANTI
DETAYI

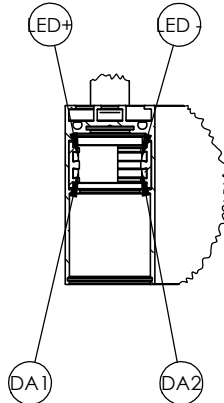

MONTAJ DETAYI :6/
ASSAMBLING DETAIL-6
DRIVER BAĞLANTI
ŞEMASI

