

L I T P A

LBS Serisi Armatürler & **LBS Series Luminaires**



IP66



Aydınlatmada dünya markası olma yolunda bir Türk markası olan **LİTA Aydınlatma**'yı tercih ettiğiniz için teşekkür ederiz.
Thank You for choosing LİTA Lighting

Ölçüler milimetredir.
Dimensions in millimeters.



Notlar

1. Eğer ,bu armatürün, harici esnek kablosu hasar görürse, üretici firma, onun yetkili servisi ya da gerekli yetkinliğe sahip kişiler tarafından yenisi ile değiştirilecektir.
2. Armatür içindeki ışık kaynağı yalnızca, üretici firma, yetkili servis ya da gerekli yetkinliğe sahip kişi tarafından değiştirilebilir.

Notes

1. *If the external flexible cable or cord of luminaire is damaged, it shall be replaced by a special cord exclusively available from the manufacturer, their service agent or similar qualified person.*
2. *The light source contained in this luminaire shall only be replaced by the manufacturer or his service agent or a similar qualified person.*

LİTA AYDINLATMA SAN. VE TİC. A.Ş. / **LİTA LIGHTING CO.**
MERKEZ (**HEAD OFFICE**) & FABRİKA (**FACTORY**) : Haraççı Hadımköy yolu Cad. No:15 Haraççı Mah.
Arnavutköy / İSTANBUL - TURKEY TEL : 90 (0) 212 683 09 87 (5 Hat) FAX : 90 (0) 212 683 09 92

www.litpa.com

Montaj Detayları / **Assembling Details**① Montaj braketleri / **Mounting brackets**

LBS6 & LBS9

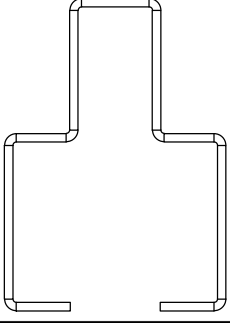

LBS12 & LBS20

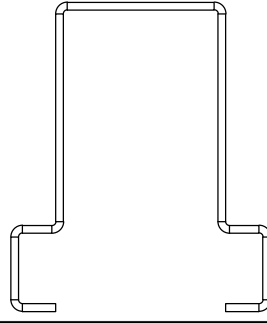
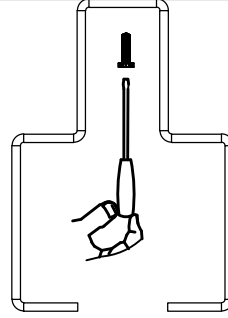
② Montaj braketini tavana vidalayınız.
Screw the mounting bracket to the ceiling

LBS6 & LBS9

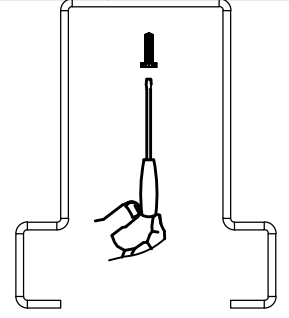

LBS12 & LBS20

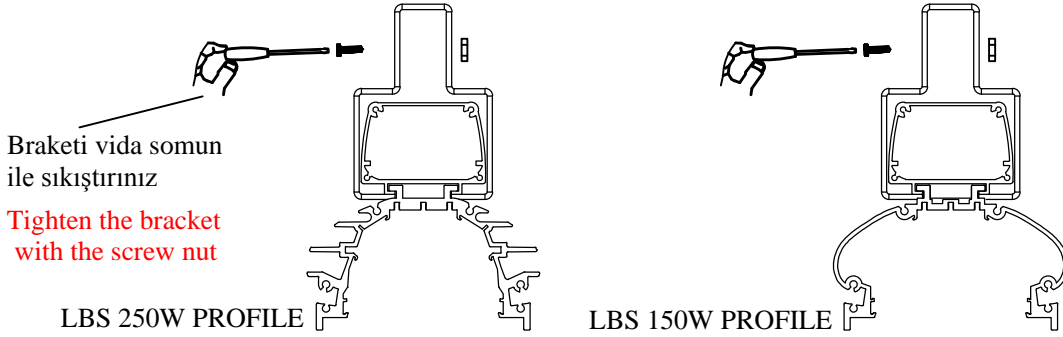
③ Armatürü braketler yardımıyla tavana sabitleyiniz. / **Fix the luminaire to the ceiling with the help of brackets****LBS6 & LBS9**

Braketi vida somun ile sıkıştırınız
Tighten the bracket with the screw nut

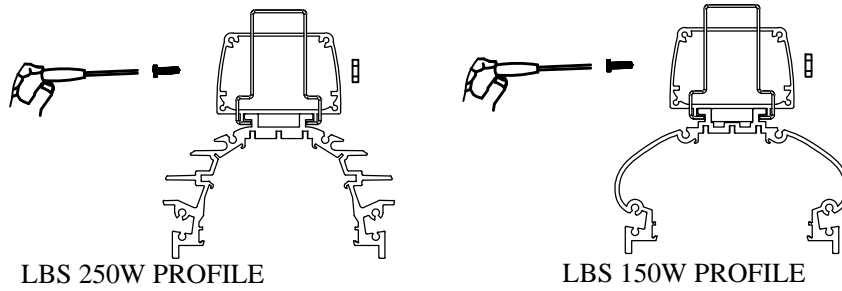
**LBS12 & LBS20**

④



Temperli
Cam

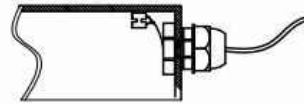

Elektrik bağlantılarını yapın
Complete the electrical connections