



DARK-LINE

Decorative Systems

Black and white reflectors are highly effective optical elements for controlled environments where light control is essential, minimizing unwanted reflections. They are particularly well-suited for offices, laboratories, and similar settings, offering an optimal lighting solution.

A key consideration is the ability to customize luminaires to meet ideal conditions while ensuring they complement the decor harmoniously. Darkline luminaires excel in such scenarios, providing both functionality and aesthetic appeal.

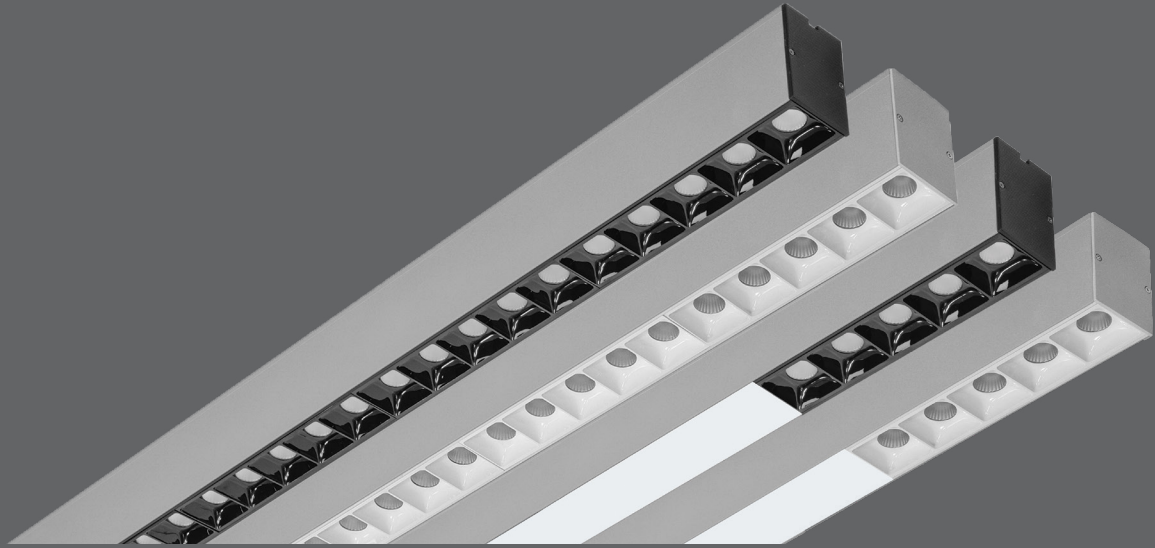

Darkline luminaires can incorporate multiple optical solutions to address different lighting requirements. Both black and white reflectors can be combined with opal diffusers for enhanced functionality.

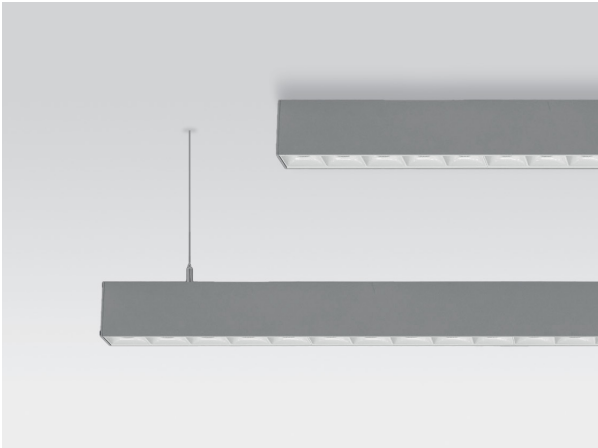

Darkline luminaires offer maximum versatility with both surface-mounted and pendant installation options. Their adaptable design allows seamless integration into diverse spaces and decorative needs.



Darkline offers white, black, and gray color options, providing design versatility that complements modern spaces with style and flexibility.



Combining sleek aesthetics with functionality, this series stands out in modern lighting solutions, while its practical installation advantage makes it a preferred choice.

RAL COLORS

Std.

9006

Opt.

9005

9016

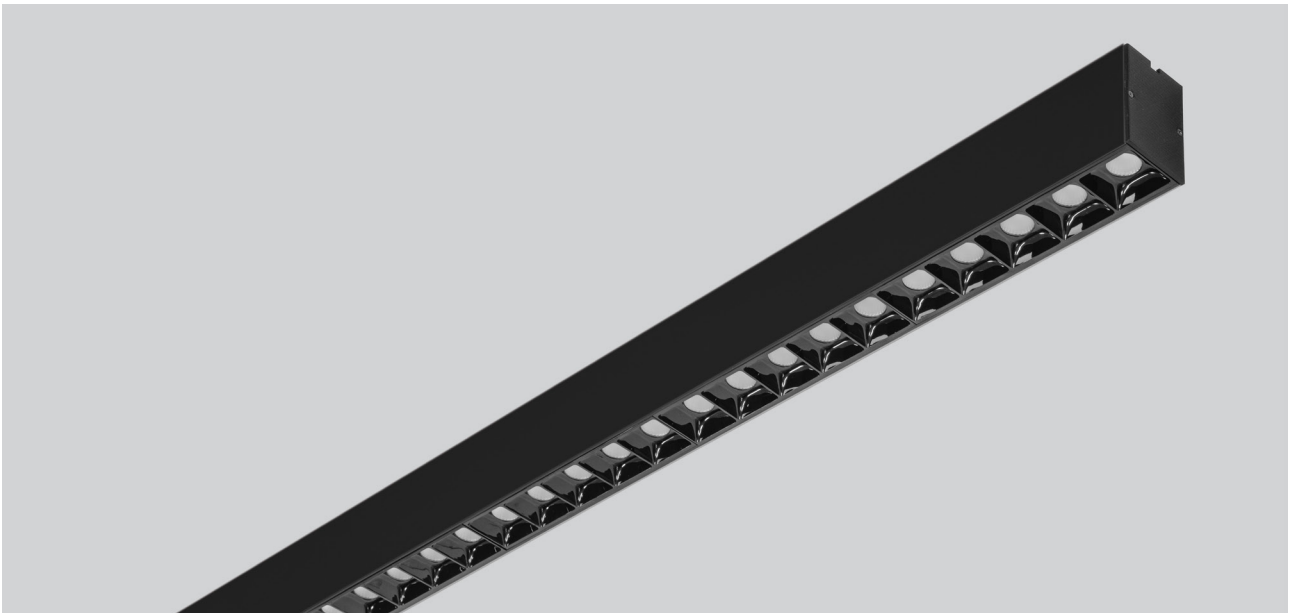

DLD/BLACK

IP20

Code	Light Direction	Beam Angle	Luminous Flux	System Power	Weight
DLD/BBBBB	Direct	45°	6.300 lm	55 W	3.6 Kg
DLE/BBBBB	Direct-Indirect	45° - 110°	6.700 lm	65 W	3.3 Kg

Body: Aluminum extrusion
Reflector: PC
Lens: PMMA

Driver: Included
Voltage: 220~240VAC

Color Temperature: 2700-3000-4000-5000-6500K, TW
Led: Mid Power Led



Surface Mounted or Pendant

Pendant



Direct Lighting (DLD)

Direct-Indirect Lighting (DLE)



BOX DIMENSIONS
122x8x14cm



BOX WEIGHT
4 kg

DLD/BBBBB

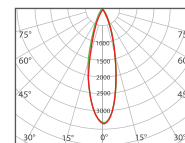

cd/klm
 - C0 - C180 - C90 - C270

DLE/BBBBB

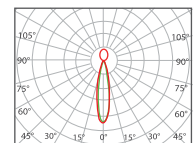

cd/klm
 - C0 - C180 - C90 - C270

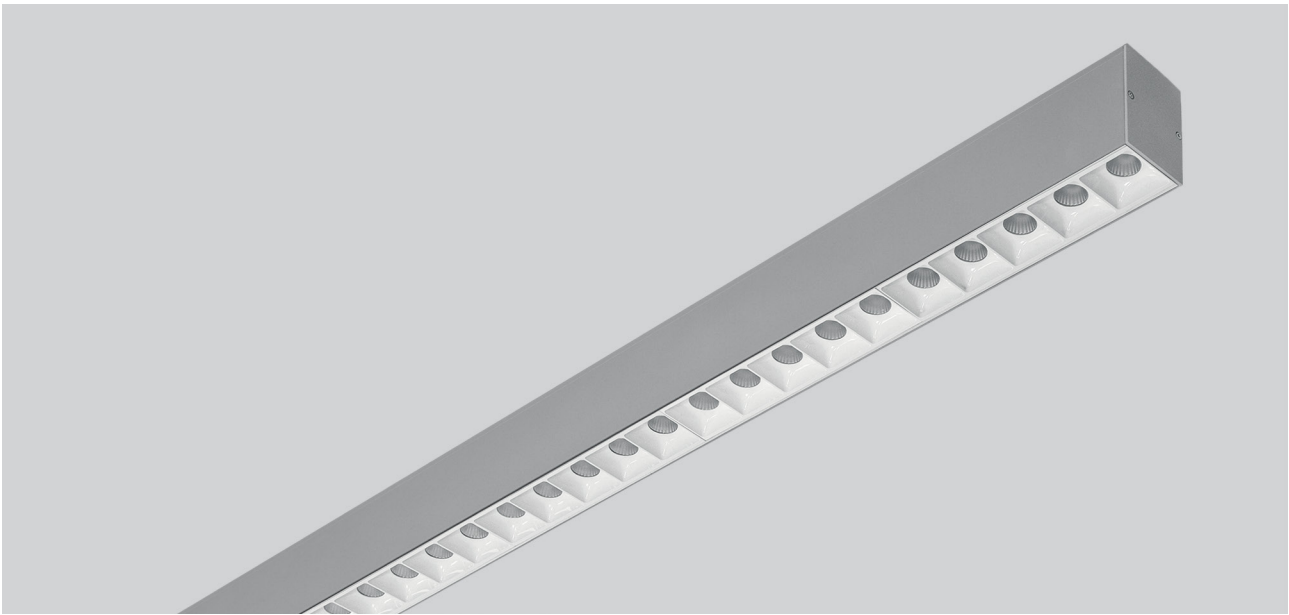

RAL COLORS

Std. 9006

Opt. 9005 9016

DLD/WHITE

IP20  

Code	Light Direction	Beam Angle	Luminous Flux	System Power	Weight
DLD/WWWWW	Direct	45°	6.300 lm	55 W	3.6 Kg
DLE/WWWWW	Direct-Indirect	45° - 110°	6.700 lm	65 W	3.3 Kg



Body: Aluminum extrusion
Reflector: PC
Lens: PMMA

Driver: Included
Voltage: 220~240VAC

Color Temperature: 2700-3000-4000-5000-6500K, TW
Led: Mid Power Led



Surface Mounted or Pendant



Direct Lighting (DLD)

Pendant



Direct-Indirect Lighting (DLE)



BOX DIMENSIONS
122x8x14cm



BOX WEIGHT
4 kg

DLD-WWWWW

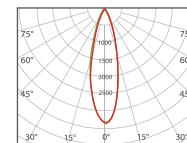

cd/klm
 - C0 - C180 - C90 - C270

DLE-WWWWW

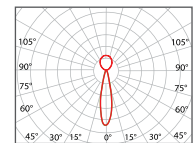

cd/klm
 - C0 - C180 - C90 - C270

RAL COLORS

- Std.  9006
- Opt.  9005
-  9016



DLD/OPAL

IP20  

Code	Light Direction	Beam Angle	Luminous Flux	System Power	Weight
DLD/O	Direct	110°	3.900 lm	35 W	3.75 Kg
DLE/O	Direct-Indirect	110°	5.300 lm	50 W	3.5 Kg

Body: Aluminum extrusion
Diffuser: Opal

Driver: Included
Voltage: 220~240VAC

Color Temperature: 2700-3000-4000-5000-6500K
Led: Mid Power



Surface Mounted or Pendant

Pendant



BOX DIMENSIONS
124x8x14cm

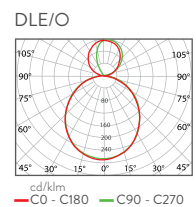
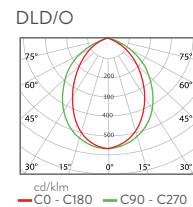

BOX WEIGHT
4 kg

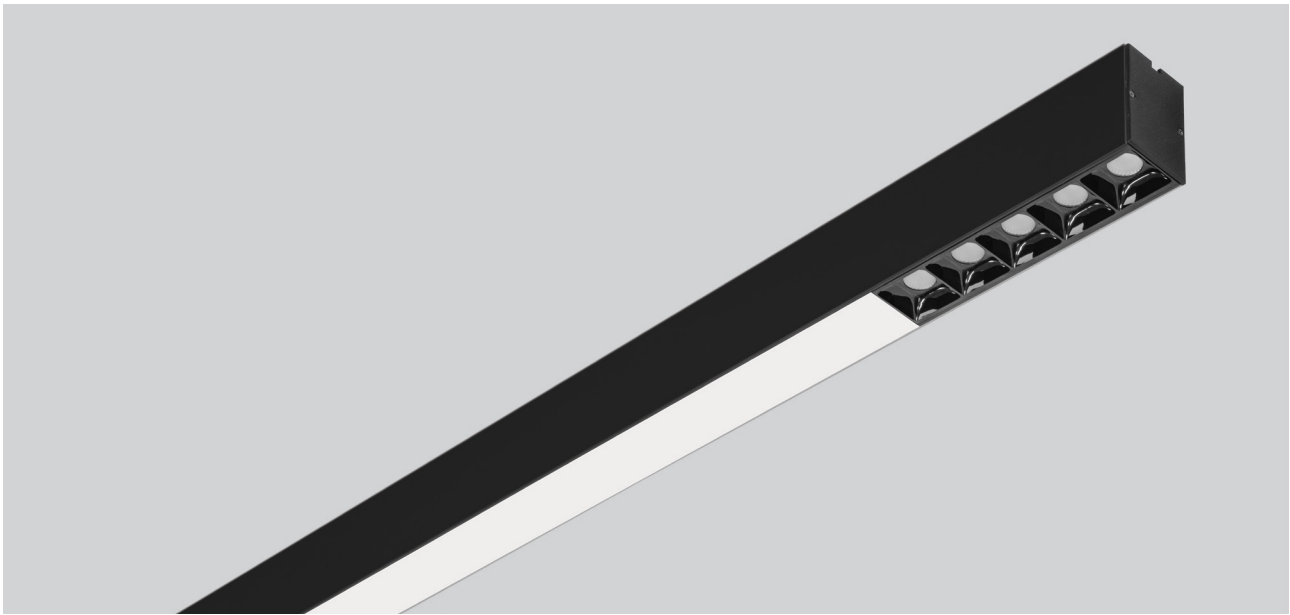



RAL COLORS

Std.  9006

Opt.  9005
 9016

DLD/BOOOB

IP20  

Code	Light Direction	Beam Angle	Luminous Flux	System Power	Weight
DLD/BOOOB	Direct	50°	5.200 lm	55 W	3.6 Kg
DLE/BOOOB	Direct-Indirect	50° - 110°	6.000 lm	65 W	3.3 Kg

Body: Aluminum extrusion
Diffuser: Opal
Reflector: PC

Driver: Included
Lens: PMMA
Voltage: 220~240VAC

Color Temperature: 2700-3000-4000-5000-6500K
Led: Mid Power



Surface Mounted or Pendant

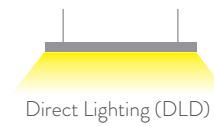

Pendant

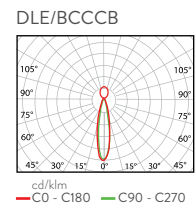
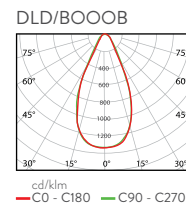

RAL COLORS

Std.

9006

Opt.

9005

9016

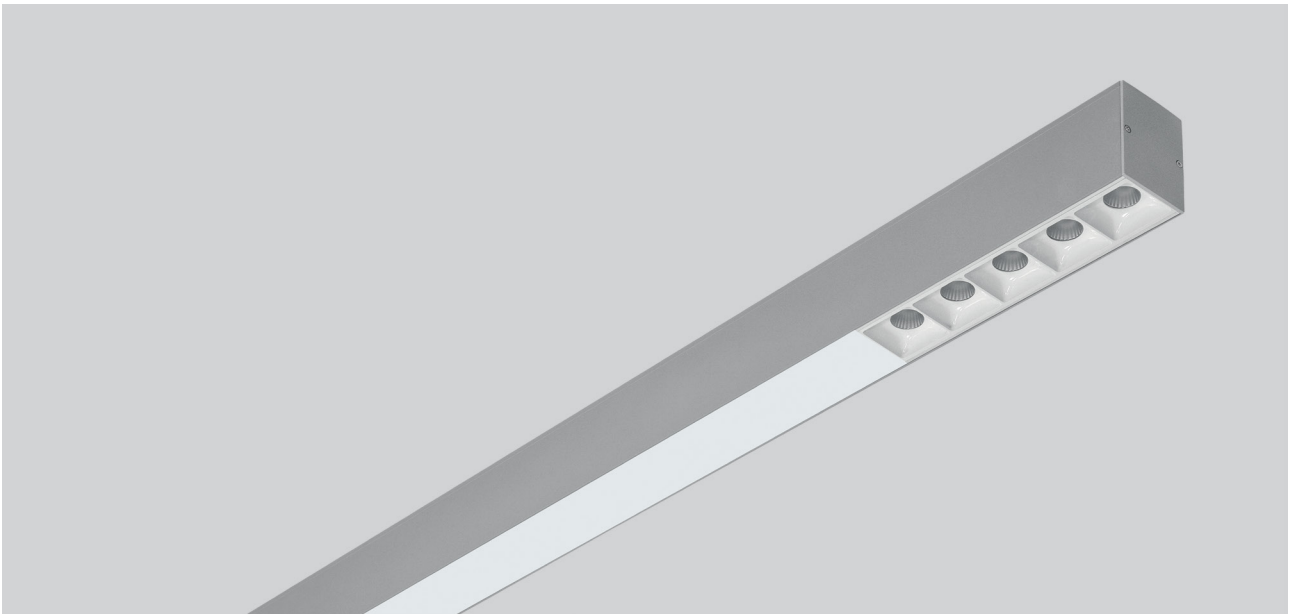

DLD/WOOOW

IP20

Code	Light Direction	Beam Angle	Luminous Flux	System Power	Weight
DLD/WOOOW	Direct	50°	5.200 lm	55 W	3.6 Kg
DLE/WOOOW	Direct-Indirect	50° - 110°	6.000 lm	65 W	3.3 Kg

Body: Aluminum Injection
Diffuser: Opal
Reflector: PC

Lens: PMMA
Driver: Included
Voltage: 220~240VAC

Color Temperature: 2700-3000-4000-5000-6500K
Led: Mid Power

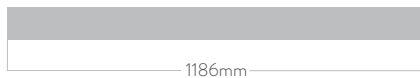
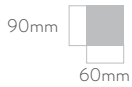

Surface Mounted or Pendant



Direct Lighting (DLD)

Pendant



Direct-Indirect Lighting (DLE)

BOX DIMENSIONS
122x8x14cm

BOX WEIGHT
4 kg

DLD-WOOOW

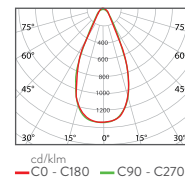

DLE/WCCCW

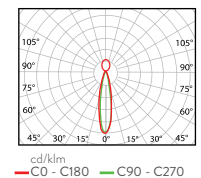

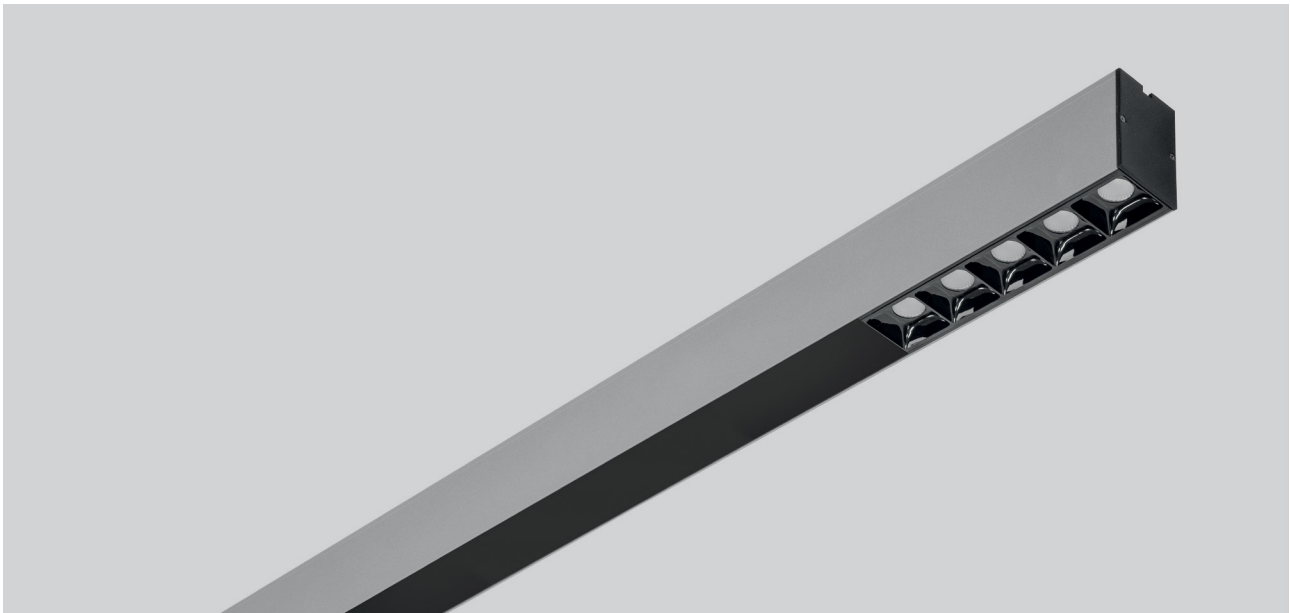

RAL COLORS

Std.
9006

Opt.
9005
9016

DLD/BCCCB

IP20  

Code	Light Direction	Beam Angle	Luminous Flux	System Power	Weight
DLD/BCCCB	Direct	45°	2.900 lm	22 W	3.6 Kg
DLE/BCCCB	Direct-Indirect	45° - 110°	3.400 lm	32 W	3.3 Kg

Body: Aluminum extrusion
Reflector: PC
Lens: PMMA

Driver: Included
Voltage: 220~240VAC

Color Temperature: 2700-3000-4000-5000-6500K
Led: Mid Power



Surface Mounted or Pendant

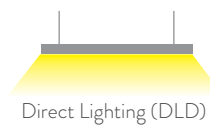

Pendant



BOX DIMENSIONS
122x8x14cm

BOX WEIGHT
4 kg

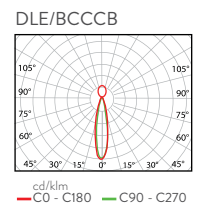
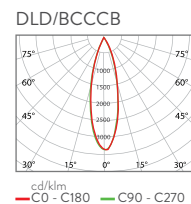

RAL COLORS

Std.

9006

Opt.

9005

9016

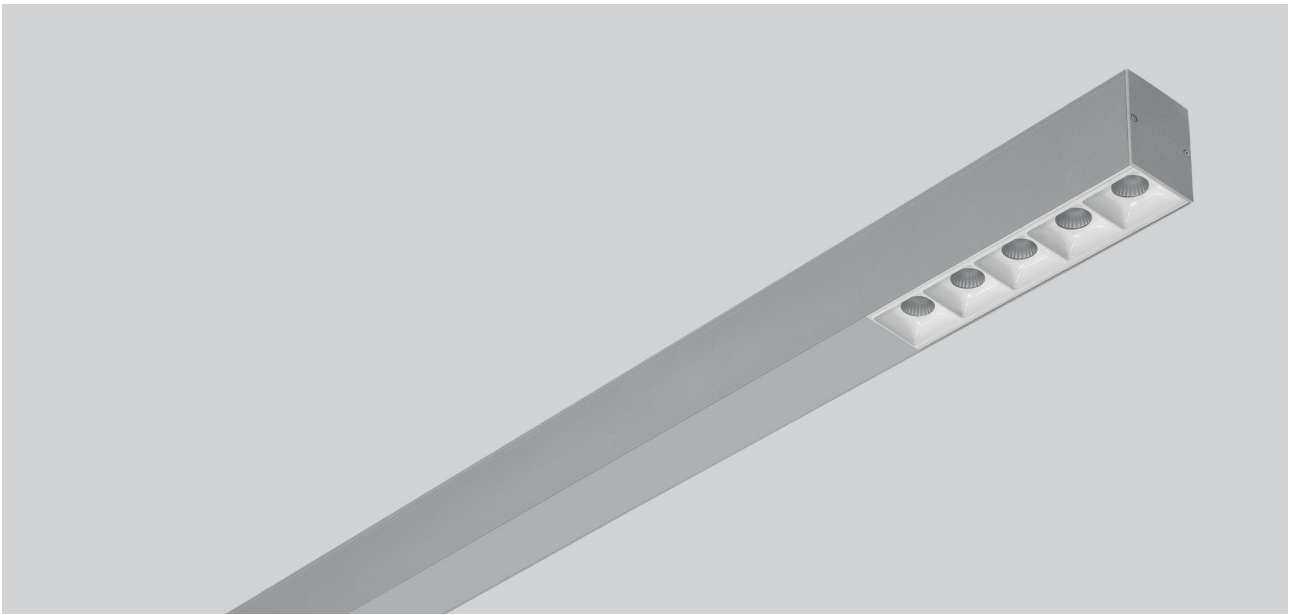

DLD/WCCCW

IP20

Code	Light Direction	Beam Angle	Luminous Flux	System Power	Weight
DLD/WCCCW	Direct	45°	2.900 lm	22 W	3.6 Kg
DLE/WCCCW	Direct-Indirect	45-110°	3.400 lm	32 W	3.3 Kg

Body: Aluminum extrusion
Reflector: PC
Lens: PMMA

Driver: Included
Voltage: 220~240VAC

Color Temperature: 2700-3000-4000-5000-6500K
Led: Mid Power

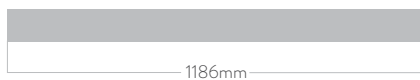
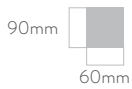

Surface Mounted or Pendant



Direct Lighting (DLD)

Pendant



Direct-Indirect Lighting (DLE)



DLD-WCCCW

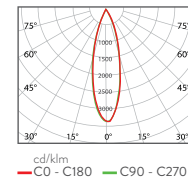

DLE/WCCCW

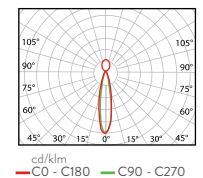



EXIT
FIRE EXIT

ÇAKIR